

Sfere portanti

Ball transfer units



Le sfere portanti, come già le rotelle Omnidirezionali, consentono di muovere per spinta in qualsiasi direzione colli la cui superficie sia sufficientemente liscia, rigida e piana.

La vasta gamma presentata consente le più svariate applicazioni e possibilità di montaggio, con capacità di carico da 15 a 2000 daN cad. sfera.

Pertanto sono impiegate non solo per trasportatori ma anche per piani di lavoro e smontaggio su macchine e transfers nell'industria meccanica, siderurgica, ecc, nonché per attrezzature di carico-scarico di automezzi o in impianti aeroportuali.

Occorre considerare attentamente che la superficie dei colli a contatto con le sfere resista all'infossamento in rapporto al carico.

Il funzionamento risulta ottimale curando il montaggio e prevedendo un margine di sicurezza nel calcolo della quantità di sfere portanti e della portata richiesta per ognuna.

Serie SPL 500

La carcassa portante, realizzata in Poliammide di colore nero, presenta forme diverse per consentire vari modi di impiego e montaggio.

La sfera portante in acciaio da 1" ruota su una quantità di piccole sfere contenute a pieno riempimento in una calotta cementata e temperata. Il rotolamento è sempre garantito da una tenuta di feltro pur mantenendo la scorrevolezza, prerogativa peculiare di questa serie. Su richiesta possono essere fornite con sfera principale in nylon.

The ball transfer units, like the Omnidirectional wheels, allow sufficiently smooth, rigid and flat surface packages to be moved in any direction.

The wide range produced allows the most various applications and installation possibilities with load capacities ranging from 15 to 2000 daN for each ball unit.

For this reason they are not only used for conveyors but also for machines and transfers working and assembly tables in the mechanical, metallurgy industry etc, for vehicle loading-unloading systems and in airport installations.

Special attention should be given to the fact that the balls should resist piercing or hollowing into the package surfaces. This is strictly related to the package weight and the system functionality is safeguarded foreseeing a security margin in the calculation of the load capacity and number of transfer ball units to be installed.

SPL 500 Series

The black colour Polyamide bodies have various designs to allow different types of installations and applications. The 1" steel ball rolls on a hardened cap filled with small balls. The sliding effect is always guaranteed by a felt sealing which maintains the smooth running property of this series.

On request they can be supplied with the main ball in nylon.

Tipo Type	Portata Load Capacity daN	Peso Weight daN	Note	
SPL 500	50	0,110	Flangia inferiore con fori <i>flange at bottom with holes</i>	standard
SPL 520	20	0,052		sfera in nylon-nylon balls
SPL 501	50	0,110	flangia superiore con fori <i>flange at top with holes</i>	standard
SPL 521	20	0,052		sfera in nylon-nylon balls
SPL 503	50	0,108	flangia superiore <i>flange at top</i>	standard
SPL 522	20	0,042		sfera in nylon-nylon balls
SPL 504	50	0,120	flangia inferiore con perno filettato	standard
SPL 512	20	0,062	<i>flange at bottom with threaded stud</i>	sfera in nylon-nylon balls

SPL 500-520

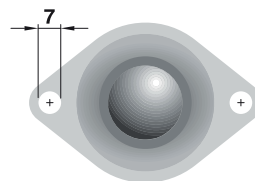
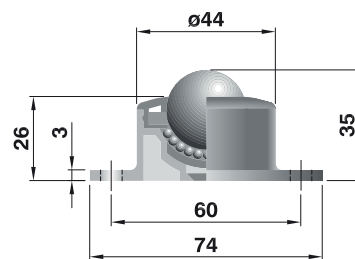

SPL 501 - 521

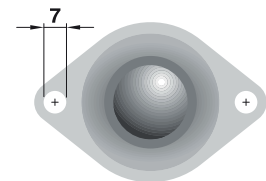
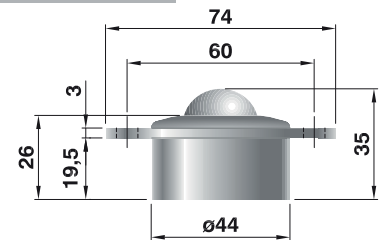

SPL 503 - 522

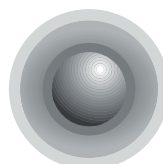
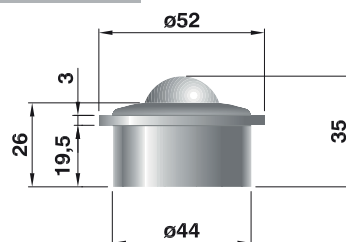

SPL 504 - 512

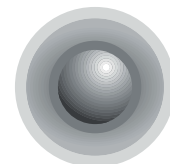
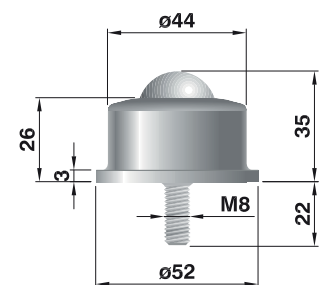

Serie SPR

Sono completamente in acciaio, zincate, più robuste rispetto alle precedenti con carcasse tornite o in lamiera stampata per la versione "L".

SPR series

All steel body with external zinc-plated parts. This series is much stronger than the previous one and its body can be machined or deep drawn for "L" version.

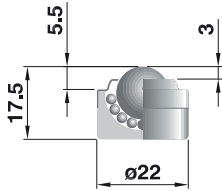
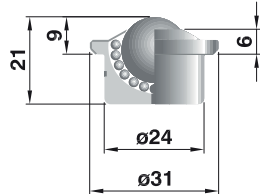
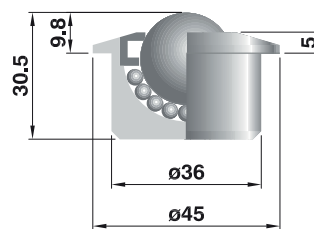
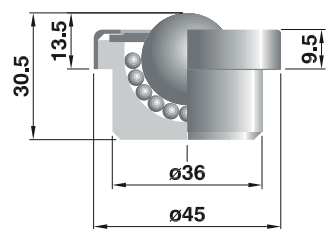
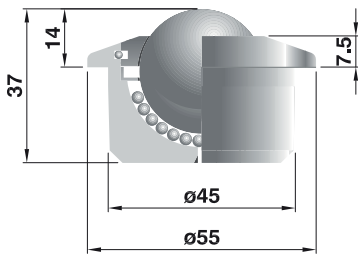
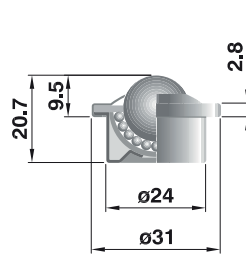
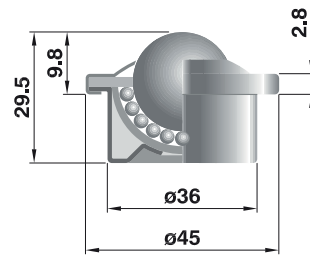
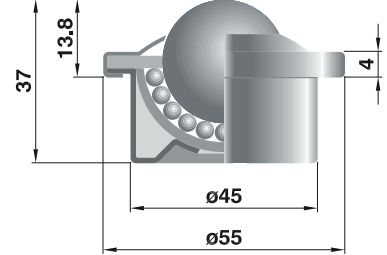
SPR 12

SPR 15

SPR 22

SPR 25

SPR 30

SPR 15L

SPR 22L

SPR 30L

Tipo Type	Diametro sfera ball diameter		Portata - Load capacity daN esec. - exec.			Peso - Weight daN esec. - exec.		
	mm	in.	B	C	BD	B	C	BD
SPR 12 B-C-BD	12,7	1/2	20	15	5	0,035	0,035	0,015
SPR 15 B-C-BD	15,87	5/8	50	40	13	0,060	0,060	0,046
SPR 22 B-C-BD	22,22	7/8	180	130	22	0,190	0,190	0,152
SPR 25 B-C-BD	25,4	1	180	130	22	0,220	0,220	0,162
SPR 30 B-C-BD	30,16	1 3/16	350	210	25	0,360	0,360	0,270
SPR 15L B-C-BD	15,87	5/8	45	35	13	0,038	0,038	0,024
SPR 22L B-C-BD	22,22	7/8	120	90	22	0,125	0,125	0,088
SPR 30L B-C-BD	30,16	1 3/16	200	140	25	0,265	0,265	0,168

NOTA

esec. B = Standard con parti zincate e sfere in acciaio
esec. C = con parti zincate e tutte le sfere inox AISI 420
esec. BD = con parti zincate e sfera principale in delrin (POM)

NOTE

esec. B = Standard with zinc-plated parts and steel balls
esec. C = with zinc-plated parts and all balls in stainless steel AISI 420
esec. BD = with zinc-plated parts and large ball in delrin (POM)

Serie SPS

Le sfere portanti di questa serie sono completamente in acciaio, costruite con degli standards di precisione e progettate per impieghi particolarmente impegnativi e specifici su transfers e piani di lavoro di macchine utensili, nei trasporti pesanti, nelle industrie metallurgiche ecc.

La loro costruzione consente l'impiego sia con "sfera in alto" che con "sfera in basso". Sono previste esecuzioni a molla per applicazioni speciali, per compensare o evitare sovraccarichi e urti o dove è necessario che la sfera portante rientri a scomparsa. Le sfere principali e le sfere di supporto sono di prima qualità, le calotte sono in acciaio cementato e temperato, le sedi di contenimento sono brunate e le tenute sono in feltro, inoltre sono imposti rigorosi test di controllo qualità. Su richiesta possono essere fornite con materiali e finiture diverse.

Tutte le dimensioni indicate in questo catalogo sono soggette a tolleranze di lavorazione e, benché i disegni siano fedeli, non sono tuttavia impegnativi.

Rulli Rulmecca si riserva il diritto di modificare i prodotti senza alcun preavviso.

SPS series

The ball units of this series are completely in stainless steel, manufactured to precision standards and designed for particularly severe and specific applications such as transfers and working tables for machine tools, heavy conveyors, metallurgic industry etc.

Their construction allows them to work in either "up" or "down" applications.

Spring executions for special applications are foreseen. These allow to compensate or avoid overloading and shock and the ball to shrink completely into the cap. The main balls and the small support balls are of first quality, the caps are case hardened, the support body is burnished and sealings are of felt. Severe quality control tests are carried out for this series. On request they can be supplied with different materials and designs.

All dimensions indicated in this catalogue are subjected to machining tolerances and, although drawings are exact, they place the manufacturer under no obligation whatsoever. Rulli Rulmecca reserves the right to modify the products at any time without any notice.

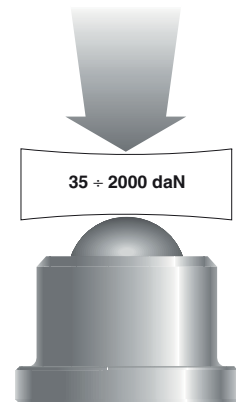

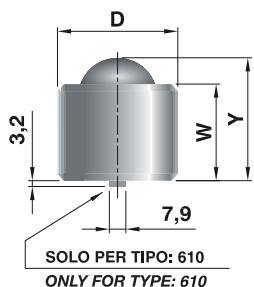

Codice di ordinazione Ordering code Tipo / Type	Diametro sfera Ball Diameter		Y	W	D	L	d	Portata Load Capacity daN	Peso Weight daN
	mm	in.							
SPS 610	12,7	½	19,1	15,3	20,6			46	0,036
SPS 611	25,4	1	41,3	35,7	44,5			225	0,383
SPS 612	25,4	1	44,5	38,1	50,8			375	0,525
SPS 613	38,1	1½	61,6	47,6	60,3			1100	1,078

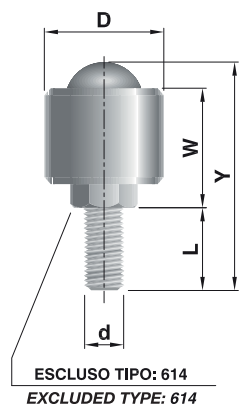

SPS 614	12,7	½	35,2	16,5	20,6	16,1	M8	46	0,043
SPS 615	25,4	1	72,7	41,7	44,0	25,4	M12	225	0,467
SPS 616	25,4	1	75,9	44,1	50,0	25,4	M12	375	0,567
SPS 617	38,1	1½	111,5	58,8	60,0	40,0	M20	1100	1,162
SPS 618	50,8	2	159,8	94,7	100,0	50,8	M24	2200	5,500

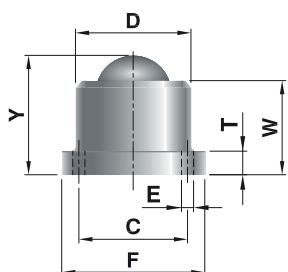

Codice di ordinazione Ordering code Tipo / Type	Diametro sfera Ball Diameter		Y	W	D	F	C	T	E ø	Portata Load Capacity daN	Peso Weight daN
	mm	in.									
SPS 619	12,7	½	22,2	18,4	23,8	Ø 44,5	Ø 34,9	3,2	2 x 3,6	46	0,078
SPS 620	25,4	1	41,3	35,7	44,0	Ø 57,2	Ø 44,5	4,8	4 x 5,6	225	0,467
SPS 621	25,4	1	44,5	38,1	50,0	Ø 76,2	Ø 57,9	6,4	4 x 8,1	375	0,766
SPS 622	38,1	1½	61,5	48,8	60,0	Ø 76,2	Ø 57,9	12,7	4 x 8,1	1100	1,248
SPS 623	50,8	2	98,4	84,1	100,0	Ø 127	Ø 101,6	9,5	4 x 11,1	2200	5,556

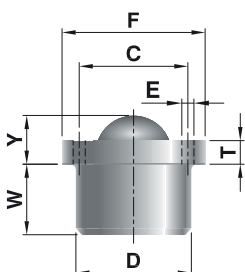

SPS 624	12,7	½	11,2	11,0	23,8	Ø 44,5	Ø 34,9	3,2	2 x 3,6	46	0,078
SPS 625	25,4	1	10,3	31,0	44,0	Ø 57,2	Ø 44,5	4,8	4 x 5,6	225	0,418
SPS 626	25,4	1	12,7	31,8	50,0	Ø 76,2	Ø 57,9	6,4	4 x 8,1	375	0,766
SPS 627	38,1	1½	25,4	34,6	60,0	Ø 76,2	Ø 57,9	12,7	4 x 8,1	1100	1,248
SPS 628	50,8	2	33,3	61,7	100,0	Ø 127	Ø 101,6	19,1	4 x 11,1	2200	5,784

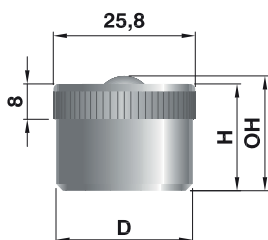
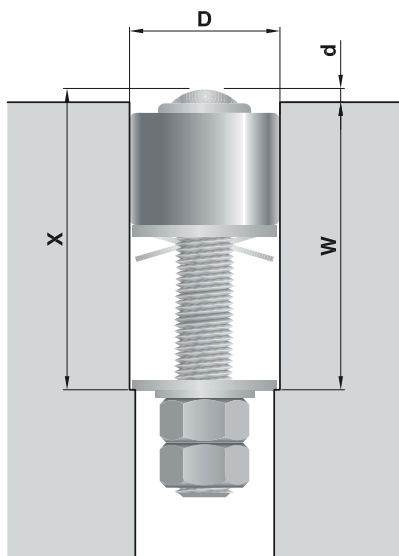
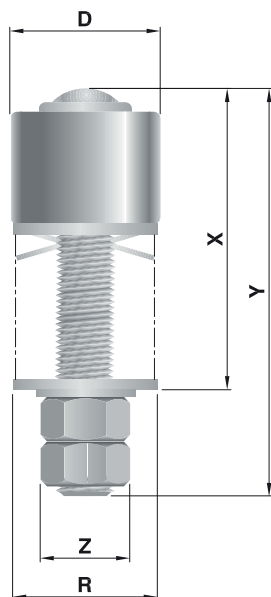

con molla esterna - external spring

Codice di ordinazione Ordering code Tipo - Type	Diametro sfera Ball Diameter		Portata Load Capacity daN	Carico massimo compressione Load max. compression daN	d*	X	Y	Z	D	R
	mm	in.								
SPS 684	12,7	½	7	32	2,0	32,20	46,20	17,46	20,60	20,00
SPS 685	12,7	½	14	38	2,0	31,80	46,20	17,46	20,60	20,00
SPS 686	12,7	½	23	38	2,0	32,20	46,20	17,46	20,60	20,00
SPS 687	25,4	1	7	136	5,4	61,90	77,00	22,22	44,50	31,80
SPS 688	25,4	1	23	136	5,0	61,50	77,00	22,22	44,50	31,80
SPS 689	25,4	1	45	136	4,4	60,90	77,00	22,22	44,50	31,80
SPS 690	25,4	1	68	136	5,3	61,80	77,00	22,22	44,50	31,80
SPS 691	25,4	1	91	331	7,7	80,80	95,30	22,22	50,80	38,10
SPS 692	25,4	1	136	331	6,5	79,60	95,30	22,22	50,80	38,10
SPS 693	25,4	1	181	331	5,8	80,50	95,30	22,22	50,80	38,10
SPS 694	25,4	1	227	331	4,6	80,95	95,30	22,22	50,80	38,10
SPS 695	38,1	1½	227	960	10,5	115,40	162,10	35,56	60,33	59,44
SPS 696	38,1	1½	318	960	11,1	121,00	162,10	35,56	60,33	59,44
SPS 697	38,1	1½	454	960	11,1	129,20	162,10	35,56	60,33	59,44
SPS 698	38,1	1½	567	960	8,8	127,00	162,10	35,56	60,33	59,44
SPS 699	38,1	1½	680	960	9,2	146,30	189,70	35,56	60,33	59,44
SPS 710	38,1	1½	748	960	8,2	156,20	189,70	57,15	60,33	59,44
SPS 780	50,8	2	764	1400	5,3	175,10	200,90	57,15	101,6	101,6
SPS 781	50,8	2	1018	1400	6,0	177,40	200,90	57,15	101,6	101,6
SPS 782	50,8	2	1273	1800	5,9	174,60	200,90	57,15	101,6	101,6
SPS 783	50,8	2	1527	2030	5,7	171,50	200,90	57,15	101,6	101,6

d* massima corsa di compressione. - maximum compression stroke.

con molla interna - internal spring

Codice di ordinazione Ordering code Tipo / Type	Diametro sfera Ball Diameter		Portata Load Capacity daN	Carico massimo compressione Load max. compression daN	d*	OH	H	D
	mm	in.						
SPS 629	12,7	½	23	40	2,0	27,4	25,4	25,4

d* massima corsa di compressione. - maximum compression stroke.