



AUTOCENTRANTE

LE TOLLERANZE DI LAVORAZIONE
DIAMETRALI CONSIGLIATE SONO:

ALBERO $\varnothing h 8$

MOZZO $\varnothing H 8$

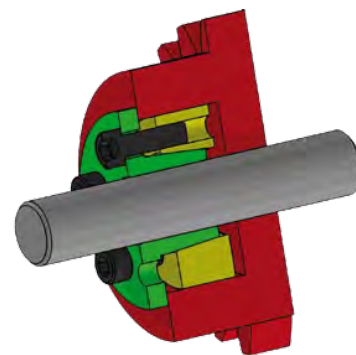
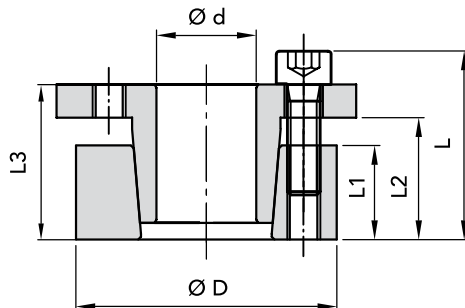

CODICE	DIMENSIONI						coppia max Mt Nm	PRESSIONI		VITI BLOCCAGGIO DIN 912 MAT. 12.9			FILETTO DI ESTRAZIONE		PESO Kg
	$\varnothing d$	$\varnothing D$	L1	L2	L3	L		Albero N/mm ²	Mozzo N/mm ²	N.	Tipo	Coppia Nm	Tipo	N.	
06160018	18	47	17	22	28	34	260	240	93	5	M6x20	17	M6	3	0,30
06160019	19	47	17	22	28	34	270	230	93	5	M6x20	17	M6	3	0,30
06160020	20	47	17	22	28	34	280	220	95	5	M6x20	17	M6	3	0,30
06160022	22	47	17	22	28	34	300	200	95	5	M6x20	17	M6	3	0,30
06160024	24	50	17	22	28	34	400	215	107	6	M6x20	17	M6	3	0,30
06160025	25	50	17	22	28	34	420	210	105	6	M6x20	17	M6	3	0,30
06160028	28	55	17	22	28	34	470	190	96	6	M6x20	17	M6	3	0,40
06160030	30	55	17	22	28	34	500	180	95	6	M6x20	17	M6	3	0,40
06160032	32	60	17	22	28	34	720	220	115	8	M6x20	17	M6	4	0,40
06160035	35	60	17	22	28	34	790	200	115	8	M6x20	17	M6	4	0,40
06160038	38	65	17	22	28	34	850	185	105	8	M6x20	17	M6	4	0,50
06160040	40	65	17	22	28	34	900	175	105	8	M6x20	17	M6	4	0,50
06160045	45	75	20	25	33	41	1620	215	125	7	M8x25	41	M8	3	0,70
06160050	50	80	20	25	33	41	1820	195	120	7	M8x25	41	M8	3	0,80
06160055	55	85	20	25	33	41	2300	200	130	8	M8x25	41	M8	4	0,90
06160060	60	90	20	25	33	41	2500	185	125	8	M8x25	41	M8	4	0,90
06160065	65	95	20	25	33	41	3050	190	130	9	M8x25	41	M8	3	1,00
06160070	70	110	24	30	40	50	4660	210	135	8	M10x30	83	M10	4	1,90
06160075	75	115	24	30	40	50	5000	195	125	8	M10x30	83	M10	4	2,00
06160080	80	120	24	30	40	50	5300	185	125	8	M10x30	83	M10	4	2,00
06160085	85	125	24	30	40	50	6350	195	135	9	M10x30	83	M10	3	2,00
06160090	90	130	24	30	40	50	6760	185	130	9	M10x30	83	M10	3	2,20
06160095	95	135	24	30	40	50	7900	195	135	10	M12x35	83	M10	4	2,30
06160100	100	145	26	32	44	56	9700	200	140	8	M12x35	145	M12	4	3,00
06160110	110	155	26	32	44	56	10600	180	130	8	M12x35	145	M12	4	3,20
06160120	120	165	34	32	44	56	13000	185	135	9	M12x35	145	M12	4	3,40
06160130	130	180	34	40	52	64	18900	175	125	12	M12x35	145	M12	6	5,20
06160140	140	190	34	40	54	68	20600	165	120	9	M14x40	230	M14	4	5,40
06160150	150	200	34	40	54	68	25100	175	130	10	M14x40	230	M14	5	5,70
06160160	160	210	34	40	54	68	29100	180	135	11	M14x40	230	M14	4	6,00
06160170	170	225	44	50	64	78	34100	140	105	12	M14x40	230	M14	6	8,30
06160180	180	235	44	50	64	78	36100	135	105	12	M14x40	230	M14	6	8,80

Esempio di ordinazione:

Albero con $\varnothing d$ 75 con un valore di coppia
uguale a 5000 Nm si chiederà:

RCK 16 - 75 x 115

Codice 06160075

