

Motion control Lexium 32

Catalogue

January **2011**



Lexium 32 motion control

Lexium 32 offer

- Presentation page 62080/2
- Servo motor/servo drive combinations page 62080/5

Lexium 32 servo drives

- References
 - Servo drives page 62083/2
 - Accessory and documentation page 62083/4
 - Dialogue tool page 62083/5
 - Configuration tools page 62083/6
 - Connection accessories page 62083/8
- Options
 - Encoder cards for Lexium 32M servo drives page 62094/2
 - Safety card for Lexium 32M servo drives page 62094/4
 - Braking resistors page 62094/6
 - Line chokes page 62094/7
 - Integrated and additional EMC input filters page 62094/8
 - Communication buses and networks page 62095/2
- SoMove setup software page 60205/2
- Motor starters page 62092/2

BMH servo motors

- Presentation page 62100/2
- References page 62102/2
- Options
 - Integrated holding brake page 62106/2
 - Integrated sensor page 62106/3
 - GBX planetary gearboxes page 62106/5
 - GBY angular planetary gearboxes page 62106/6

BSH servo motors

- Presentation page 62110/2
- References page 62112/2
- Options
 - Integrated holding brake page 62116/2
 - Integrated sensor page 62116/3
 - GBX planetary gearboxes page 62116/5
 - GBY angular planetary gearboxes page 62116/6

PF009034

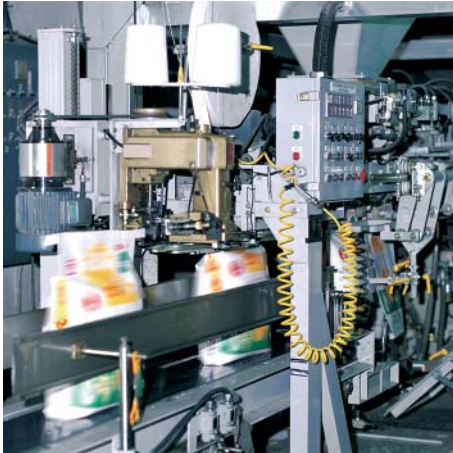

Lexium 32 servo drive controlling a packaging machine

PF009032



Lexium 32 servo drive controlling an handling machine

PF009033



Lexium 32 servo drive controlling a material working machine

Presentation

The Lexium 32 range of servo drives includes three servo drive models associated with two servo motor ranges for optimum use which can adapt to demands for high performance, power and simplicity of use in motion control applications. It covers power ratings between 0.15 and 7 kW.

The Lexium 32 servo drive offer is designed to simplify the life cycle of machines. The SoMove setup software, SoMove Mobile software, side-by-side mounting and colour-coded plug-in connectors, easily accessible on the front panel or on top of the servo drives, all make installation, setup and maintenance easier. Maintenance is also quicker and cheaper thanks to the new duplication and backup tools, such as the memory card.

Performance is improved by optimized motor control: reduction of vibration with automatic parameter calculation, speed observer, additional band-stop filter. This optimization increases machine productivity.

The compact size of the servo drives and servo motors provides maximum power in the minimum space, enabling the machine dimensions and costs to be reduced.

Integrated communication or optional communication cards, depending on the model, as well as standard encoders, enable adaptation to numerous types of control system architecture for industry.

Integrated safety function and access to additional safety functions reduce design times and make it easier to comply with safety standards.

Applications for industrial machines

The Lexium 32 servo drive incorporates functions which are suitable for the most common applications, including:

- Printing: cutting, machines with position control, etc.
- Packaging and wrapping: cutting to length, rotary knife, bottling, capsuling, labelling, etc.
- Textiles: winding, spinning, weaving, embroidery, etc.
- Handling: conveying, palletization, warehousing, pick and place, etc.
- Transfer machines (gantry cranes, hoists), etc.
- Clamping, "on the fly" cutting operations (flying shear, printing, marking), etc.
- Material working.

The offer

The Lexium 32 range of servo drives covers motor power ratings between 0.15 kW and 7 kW with three types of power supply:

- 110...120 V single-phase, 0.15 kW to 0.8 kW (**LXM 32●●●●M2**)
- 200...240 V single-phase, 0.3 kW to 1.6 kW (**LXM 32●●●●M2**)
- 208...480 V three-phase, 0.4 kW to 7 kW (**LXM 32●●●●N4**)

Compliance with international standards and certifications

The entire range conforms to international standards IEC/EN 61800-5-1, IEC/EN 61800-3, is UL and CSA certified, and has been developed to meet the requirements of directives regarding protection of the environment (RoHS) as well as those of European Directives to obtain the CE mark.

Compliance with electromagnetic compatibility (EMC) requirements

The integration of a category C3 EMC filter in Lexium 32 servo drives and compliance with EMC simplify installation and make it very inexpensive to bring the device into conformity to obtain the CE mark.

Additional filters, available as an option, can be installed by the customer to reduce the level of conducted and radiated emissions (see page 62094/8). They also enable the servo drive to be used with cable lengths of up to 100 metres, to meet the requirements of applications in a wide variety of fields.

Accessories and options

External accessories and options such as braking resistors, line chokes, etc. enhance this offer.

Simplicity, from installation to maintenance



Human-Machine Interface (HMI)	The display can be used to control and configure the servo drive, display states and faults, access parameters and modify them in manual mode using the navigation button.
Remote graphic display terminal 1	The Lexium 32 servo drive can be connected to a remote display terminal, available as an option. This terminal can be mounted on an enclosure door with IP 54 degree of protection. It provides access to the same functions as the Human-Machine interface and some additional functions (see page 62083/5).
SoMove Mobile software 2	The SoMove Mobile software converts any mobile phone into a remote graphic display terminal, offering an identical Human-Machine Interface (see page 62083/6).
SoMove setup software 3	The SoMove setup software is used to configure and optimize control loops with the Oscilloscope function in automatic mode or in manual mode, and also for maintenance of the Lexium 32 servo drive, like all other Schneider Electric drives and starters. It can be used with a Bluetooth® wireless connection (see page 62083/6).
Multi-Loader tool 4	The Multi-Loader tool enables configurations to be copied from a PC or a servo drive and loaded onto another servo drive. The servo drives can be powered-down (see page 62083/7).
Memory card 5	This stores all the servo drive parameters. When replacing a Lexium 32 servo drive, this function ensures immediate startup since the programming time has been eliminated. Maintenance time is optimized, and costs reduced (see page 62083/7).
Auto-tuning	Adapted to each user, the three auto-tuning levels, automatic, semi-automatic and expert, allow your machine to achieve a high level of performance, whatever the application.
Mounting and maintenance	Several Lexium 32 servo drives can be mounted side by side to save space. Connecting the servo drives is simplified by colour-coded plug-in connectors, which are easily accessed on the front panel or on top of the drive.



Example of control system architecture with CANopen and CANmotion machine bus

High performance

The Lexium 32 servo drive offer increases machine performance due to the following characteristics:

- Overload capacity: the high peak current (up to 4 times the direct current) increases the range of movement
- Power density: the compact size of the servo drives offers maximum efficiency in a small space
- High bandwidth: better speed stability and faster acceleration improve the quality of control
- Motor control: reduction of vibration, speed observer and additional band-stop filter enhance the quality of control

A design suitable for the various different control system structures

Its versatile specifications provide the Lexium 32 range of servo drives with excellent flexibility for integration in different control system structures.

Depending on the model, the Lexium 32 servo drive has logic or analog inputs and outputs as standard, which can be configured to adapt better to applications. It also has control interfaces for easy access to the various architecture levels:

- It has a control interface for control via pulse train
- It integrates a combined CANopen/CANmotion port for enhanced control system performance
- It can also be connected to the main industrial communication networks and buses using various communication cards

The following protocols are available: PROFIBUS DP V1, DeviceNet, EtherNet/IP and EtherCAT.

Functions dedicated to safety

The Lexium 32 range of servo drives forms part of a control system's safety system since it integrates the "Safe Torque Off" (STO) function, which prevents unintended restarting of the servo motor.

This function complies with standard IEC/EN 61508 level SIL3 governing electrical installations and the power drive systems standard IEC/EN 61800-1.

It simplifies the setup of installations which require a complex safety device, and improves performance during maintenance operations by reducing the time required and increasing safety.

An additional eSM module is available for accessing enhanced safety functions.

BMH and BSH servo motors: dynamics and power

BMH and BSH servo motors are synchronous three-phase motors.

They feature a SinCos Hiperface® encoder for sending data from the servo motor to the servo drive automatically, and are available with or without a holding brake.

BMH servo motors

BMH servo motors are motors with medium inertia. They are perfectly adapted to high-load applications and allow the movement to be adjusted in a more robust manner.

This product offer covers a continuous stall torque range between 1.2 Nm and 84 Nm for nominal speeds between 1200 and 5000 rpm.

BSH servo motors

BSH servo motors satisfy requirements for precision and high dynamic performance, due to the low rotor inertia. They are compact, and offer a high power density.

This product offer covers a continuous stall torque range between 0.5 Nm and 33.4 Nm for nominal speeds between 2500 and 6000 rpm.

Main functions				
Type of servo drive		LXM 32C	LXM 32A	LXM 32M
Communication	Integrated	Modbus serial link Pulse train	Modbus serial link CANopen, CANmotion machine bus	Modbus serial link Pulse train
	As an option	–	–	CANopen, CANmotion machine bus, DeviceNet, EtherNet/IP, PROFIBUS DP V1, EtherCAT
	Operating modes	Manual mode (JOG) Electronic gearbox Speed control Current control	Homing Manual mode (JOG) Speed control Current control Position control	Homing Manual mode (JOG) Motion sequence Electronic gearbox Speed control Current control Position control
	Functions	Auto-tuning, monitoring, stopping, conversion		
24 V $\overline{\text{---}}$ logic inputs (1)	6, reassignable	–	–	4, reassignable
24 V $\overline{\text{---}}$ capture inputs (1) (2)	–	1	–	2
24 V $\overline{\text{---}}$ logic outputs (1)	5, reassignable	–	–	3, reassignable
Analog inputs	2	–	–	–
Pulse control input	1, configurable as: ■ RS 422 link ■ 5 V or 24 V push-pull ■ 5 V or 24 V open collector	–	–	1, configurable as: ■ RS 422 link ■ 5 V or 24 V push-pull ■ 5 V or 24 V open collector
ESIM PTO output	RS 422 link	–	–	RS 422 link
Human/Machine Interface	Via integrated display terminal:	Manual mode (positive/negative, fast/slow), auto-tuning, simple startup, display of information and errors, homing for Lexium 32A and 32M		
Safety functions	Integrated	"Safe Torque Off" STO		
	As an option	–	–	Safe Stop 1 (SS1) and Safe Stop 2 (SS2) Safe Operating Stop (SOS) Safe Limited Speed (SLS)
Sensor	Integrated	SinCos Hiperface® sensor		
	As an option	–	–	Resolver encoder Analog encoder Digital encoder
Architecture		Control via: ■ Logic or analog I/O	Control via: ■ Motion controller via CANopen and CANmotion machine bus	Control via: ■ Schneider Electric or third- party PLCs via communication buses and networks
Type of servo motor		BMH	BSH	
Application type		High load With robust adjustment of the movement	High dynamic response Power density	
Flange size		70, 100, 140 and 205	55, 70, 100 and 140	
Continuous stall torque		1.2 to 84 Nm	0.5 to 33.4 Nm	
Encoder type		Single turn SinCos: ■ 32,768 points/turn and ■ 131,072 points/turn Multiturn SinCos: ■ 32,768 points/turn x 4096 turns and ■ 131,072 points/turn x 4096 turns	Single turn SinCos: ■ 131,072 points/turn Multiturn SinCos: ■ 131,072 points/turn x 4096 turns	
Degree of protection	Casing	IP 65 (IP 67 conformity kit as an option)		
	Shaft end	IP 50 or IP 65 (IP 67 conformity kit as an option)		

(1) Unless otherwise stated, the logic I/O can be used in positive logic (Sink inputs, Source outputs) or negative logic (Source inputs, Sink outputs).
 (2) The capture inputs can be used as standard logic inputs.

Lexium 32 motion control

Supply voltage 100...120 V single phase
Servo drive/servo motor combinations

Lexium 32 servo drive/BMH or BSH servo motor combinations

Servo motors

Lexium 32C, 32A and 32M servo drives

100...120 V single-phase supply voltage with integrated EMC filter



BMH (IP 50 or IP 65)		BSH (IP 50 or IP 65)	
Type of servo motor	Rotor inertia kgcm ²	Type of servo motor	Rotor inertia kgcm ²
		BSH 0551T	0.06
		BSH 0552T	0.10
		BSH 0553T	0.13
BMH 0701T	0.59		
		BSH 0701T	0.25
		BSH 0702T	0.41
BMH 0702T	1.13		
BMH 0703T	1.67		
		BSH 1001T	1.40
BMH1001T	3.2		
BMH1002T	6.3		

LXM 32•U90M2 Continuous output current: 3 A rms			
Nominal operating point			Stall torques
Nominal torque	Nominal speed	Nominal power	$M_v/M_{max} (1)$
Nm	rpm	W	Nm/Nm
0.49	3000	150	0.5/1.5
0.77	3000	250	0.8/1.9

(1) - M_v : Continuous stall torque
- M_{max} : Peak stall torque



LXM 32-D18M2 Continuous output current: 6 A rms			
Nominal operating point			Stall torques
Nominal torque	Nominal speed	Nominal power	$M_0/M_{max} (1)$
Nm	rpm	W	Nm/Nm
1.14	3000	350	1.2/3.3
1.35	2500	350	1.4/4.2
1.36	2500	350	1.4/3.5

LXM 32-D30M2 Continuous output current: 10 A rms			
Nominal operating point			Stall torques
Nominal torque	Nominal speed	Nominal power	$M_0/M_{max} (1)$
Nm	rpm	W	Nm/Nm
2.07	2500	550	2.2/6.1
2.3	2500	600	2.5/6.4
3.1	2000	650	3.4/8.7
2.75	2500	700	3.3/6.3
3.3	2000	700	3.4/8.9
3.5	2000	750	6/10.3

Lexium 32 motion control

Supply voltage 200...240 V single phase
Servo drive/servo motor combinations

Lexium 32 servo drive/BMH or BSH servo motor combinations

Servo motors

Lexium 32C, 32A and 32M servo drives

200...240 V single-phase supply voltage with integrated EMC filter



BMH (IP 50 or IP 65)		BSH (IP 50 or IP 65)		LXM 32●U45M2 Continuous output current: 1.5 A rms			
Type of servo motor	Rotor inertia kgcm ²	Type of servo motor	Rotor inertia kgcm ²	Nominal operating point			Stall torques
				Nominal torque	Nominal speed	Nominal power	M ⁰ /M _{max} ⁽¹⁾
				Nm	rpm	W	Nm/Nm
		BSH 0551T	0.06	0.45	6000	300	0.5/1.4
		BSH 0552T	0.10				
		BSH 0553T	0.13				
		BSH 0701T	0.25				
BMH 0701T	0.59						
		BSH 0702T	0.41				
		BSH 0703T	0.58				
BMH 0702T	1.13						
		BSH 1001T	1.40				
BMH 0703T	1.67						
BMH 1001T	3.2						
		BSH 1002T	2.31				
BMH 1002T	6.3						
BMH 1003T	9.4						
BMH 1401P	16.5						

(1) - M_c: Continuous stall torque
- M_{max}: Peak stall torque



LXM 32•U90M2 Continuous output current: 3 A rms				LXM 32•D18M2 Continuous output current: 6 A rms				LXM 32•D30M2 Continuous output current: 10 A rms			
Nominal operating point			Stall torques	Nominal operating point			Stall torques	Nominal operating point			Stall torques
Nominal torque	Nominal speed	Nominal power	$M_0/M_{max} (1)$	Nominal torque	Nominal speed	Nominal power	$M_0/M_{max} (1)$	Nominal torque	Nominal speed	Nominal power	$M_0/M_{max} (1)$
Nm	rpm	W	Nm/Nm	Nm	rpm	W	Nm/Nm	Nm	rpm	W	Nm/Nm
0.74	6000	450	0.8/2.5								
0.84	6000	550	1.2/3								
0.94	5000	500	1.3/3.5								
1.1	4000	450	1.4/4								
				1.8	5000	950	2.2/7.2				
				2.1	4000	900	2.6/7.4				
				2.1	4000	900	2.5/7.4				
				2.2	4000	900	2.7/7.5				
				2.9	3000	900	3.4/10.2				
				2.8	3000	900	3.4/10.2				
								3.7	4000	1500	5.8/16.4
								4.6	3000	1450	6/18.4
								5.6	2500	1450	8/23.5
								8.9	1500	1450	10.3/30.8

Lexium 32 servo drive/BMH or BSH servo motor combinations

Servo motors

Lexium 32C, 32A and 32M servo drives

208...480 V three-phase supply voltage with integrated EMC filter



BMH (IP 50 or IP 65)		BSH (IP 50 or IP 65)		LXM 32●U60N4 Continuous output current: 1.5 A rms				LXM 32●D12N4 Continuous output current: 3 A rms			
Motor type	Rotor inertia	Motor type	Rotor inertia	Nominal operating point			Stall torques	Nominal operating point			Stall torques
	kgcm ²		kgcm ²	Nominal torque	Nominal speed	Nominal power	M ⁰ /M ^{max} (1)	Nominal torque	Nominal speed	Nominal power	M ⁰ /M ^{max} (1)
				Nm	rpm	W	Nm/Nm	Nm	rpm	W	Nm/Nm
		BSH 0551P	0.06	0.48	6000	300	0.5/1.5				
		BSH 0552P	0.10	0.65	6000	400	0.8/2.5				
		BSH 0553P	0.13	0.65	6000	400	1.05/3.5				
BMH 0701P	0.59			1.1	3000	350	1.2/4.2				
BMH 0701P	0.59							1.3	5000	700	1.4/4.2
		BSH 0701P	0.25					1.32	5000	700	1.4/3.5
		BSH 0702P	0.41					1.64	5000	850	2.2/7.6
BMH 1001P	3.2							1.9	4000	800	3.3/10.8
BMH 0702P	1.13							2.2	3000	700	2.5/7.4
BMH 0703T	1.67										
		BSH 0703P	0.58								
		BSH 1001P	1.40								
BMH 1001P	3.2										
BMH 1002P	6.3										
		BSH 1002P	2.31								
BMH 1003P	9.4										
		BSH 1003P	3.2								
BMH 1401P	16.5										
		BSH 1004P	4.2								
		BSH 1401P	7.4								
BMH 1402P	32.0										
		BSH 1402T	12.7								
		BSH 1403T	17.9								
BMH 1403P	47.5										
		BSH 1404P	23.7								
BMH 2051P	71.4										
BMH 2052P	129										
BMH 2053P	190										

(1) - M₀: Continuous stall torque
- M_{max}: Peak stall torque



LXM 32C●●●●●●



LXM 32A●●●●●●

Lexium 32C, 32A and 32M servo drives							
Output current at 8 kHz		Nominal power at 8 kHz	Line current (2)		Max. prospective line I _{sc}	Reference	Weight
Continuous (rms)	Peak (rms) (1)		A	A	kA		kg
A	A	kW	A	A	kA		kg
Single-phase supply voltage: 115 V ~ 50/60 Hz, with integrated EMC filter (3)							
1.5	3	0.15	2.9		1	LXM 32CU45M2	1.600
						LXM 32AU45M2	1.600
						LXM 32MU45M2	1.700
3	6	0.3	5.4		1	LXM 32CU90M2	1.700
						LXM 32AU90M2	1.700
						LXM 32MU90M2	1.800
6	10	0.5	8.5		1	LXM 32CD18M2	1.800
						LXM 32AD18M2	1.800
						LXM 32MD18M2	1.900
10	15	0.8	12.9		1	LXM 32CD30M2	2.000
						LXM 32AD30M2	2.000
						LXM 32MD30M2	2.100
Single-phase supply voltage: 230 V ~ 50/60 Hz, with integrated EMC filter (3)							
1.5	4.5	0.3	2.9		1	LXM 32CU45M2	1.600
						LXM 32AU45M2	1.600
						LXM 32MU45M2	1.700
3	9	0.5	4.5		1	LXM 32CU90M2	1.700
						LXM 32AU90M2	1.700
						LXM 32MU90M2	1.800
6	18	1	8.4		1	LXM 32CD18M2	1.800
						LXM 32AD18M2	1.800
						LXM 32MD18M2	1.900
10	30	1.6	12.7		1	LXM 32CD30M2	2.000
						LXM 32AD30M2	2.000
						LXM 32MD30M2	2.100
Dimensions (overall)						W x H x D	mm
LXM 32CU45M2, CU90M2, CD18M2 LXM 32AU45M2, AU90M2, AD18M2						48 x 270 x 237	
LXM 32MU45M2, MU90M2, MD18M2, MD30M2 LXM 32CD30M2 LXM 32AD30M2						68 x 270 x 237	

(1) Maximum value for 1 second
 (2) Without line choke (see page 62094/7)
 (3) Additional EMC filters available as an option (see page 62094/8)

PF516057



LXM 32M●●●●●●

Lexium 32C, 32A and 32M servo drives (continued)							
Output current at 8 kHz		Nominal power at 8 kHz	Line current (2)		Max. prospective line Isc	Reference	Weight
Continuous (rms)	Peak (rms)(1)		A	A	kA		kg
Three-phase supply voltage: 208 V ~ 50/60 Hz, with integrated EMC filter (3)							
1.5	6	0.4	1.4		5	LXM 32CU60N4	1.700
						LXM 32AU60N4	1.700
						LXM 32MU60N4	1.800
3	12	0.9	3		5	LXM 32CD12N4	1.800
						LXM 32AD12N4	1.800
						LXM 32MD12N4	1.900
6	18	1.8	5.5		5	LXM 32CD18N4	2.000
						LXM 32AD18N4	2.000
						LXM 32MD18N4	2.100
10	30	3	8.7		5	LXM 32CD30N4	2.600
						LXM 32AD30N4	2.600
						LXM 32MD30N4	2.700
24	72	7	18.1		5	LXM 32CD72N4	–
						LXM 32AD72N4	–
						LXM 32MD72N4	–
Three-phase supply voltage: 480 V ~ 50/60 Hz, with integrated EMC filter (3)							
1.5	6	0.4	1.2		5	LXM 32CU60N4	1.700
						LXM 32AU60N4	1.700
						LXM 32MU60N4	1.800
3	12	0.9	2.4		5	LXM 32CD12N4	1.800
						LXM 32AD12N4	1.800
						LXM 32MD12N4	1.900
6	18	1.8	4.5		5	LXM 32CD18N4	2.000
						LXM 32AD18N4	2.000
						LXM 32MD18N4	2.100
10	30	3	7		5	LXM 32CD30N4	2.600
						LXM 32AD30N4	2.600
						LXM 32MD30N4	2.700
24	72	7	14.6		5	LXM 32CD72N4	–
						LXM 32AD72N4	–
						LXM 32MD72N4	–
Dimensions (overall)						W x H x D	mm
LXM 32CU45N4, CD12N4, CD18N4 LXM 32AU60N4, AD12N4, AD18N4						48 x 270 x 237	
LXM 32MU60N4, MD12N4, MD18N4, MD30N4 LXM 32CD30N4 LXM 32AD30N4						68 x 270 x 237	
LXM 32●D72N4						108 x 270 x 237	

(1) Maximum value for 1 second

(2) Without line choke (see page 62094/7)

(3) Additional EMC filters available as an option (see page 62094/8)

Servo drive name plate				
Description	Use	Dimensions mm	Reference	Weight kg
Name plate (sold in multiples of 50)	This contains information about the servo drive. To be clipped onto the top right-hand part of the servo drive	385 x 130	VW3 M2 501	–
Documentation				
Description			Reference	Weight kg
"Description of the Motion & Drives offer" DVD-ROM (1)			VW3 A8 200	0.100
Comprising:				
<ul style="list-style-type: none"> ■ Technical documentation (programming manuals, installation manuals, quick reference guides) ■ SoMove Lite setup software ■ Catalogues, brochures 				
Simplified Lexium 32 user's manual			Available on our website www.schneider-electric.com	–

(1) The documentation for the servo drives and servo motors is also available on our website www.schneider-electric.com.

Remote graphic display terminal (to be ordered separately) (1)

Lexium 32 servo drives can be connected to a remote graphic display terminal, which can be used remotely using remote mounting accessories. It can be mounted on an enclosure door with IP 54 degree of protection.

This terminal is common to various ranges of variable speed drives or servo drives. It has a graphic screen and is used to access the same functions as the integrated display and control keys on the servo drive, as well as some additional functions. It can be used for example to:

- Configure, adjust and control the servo drive remotely
- Display the servo drive status and faults remotely
- Override the servo drive I/O
- Execute motion sequences
- Load configurations

Its main characteristics are as follows:

- The graphic screen displays 8 lines of 24 characters of plain text.
- The navigation button provides quick and easy access to the drop-down menus.
- It is supplied with six languages installed as standard (Chinese, English, French, German, Italian and Spanish). Other languages can be downloaded to the flash memory using the VW3 A8 121 Multi-Loader configuration tool (see page 62083/7). Its maximum operating temperature is 60°C.



Graphic display terminal
+ remote-mounting cordset
+ female/female RJ45 adaptor

Description

- 1 Graphic display:
 - 8 lines of 24 characters, 240 x 160 pixels
 - Large digit display
 - Bar chart display
- 2 Function keys F1, F2, F3, F4
- 3 "ESC" key: aborts a value, a parameter or a menu to return to the previous selection
- 4 "FWD/REV" key: Local control for reversing the direction of rotation of the motor
- 5 Navigation button:
 - Rotate ±: Goes to the next or previous line, increases or decreases the value
 - Press: Saves the current value ("ENT")
- 6 Motor local control keys:
 - "RUN": Starts the motor
 - "STOP/RESET": Local control of motor stopping/clearing drive faults
- 7 Remote graphic display terminal
- 8 Remote-mounting cordset
- 9 Female/female RJ45 adaptor

References

Description	Item no.	Length m	Reference	Weight kg
Remote graphic display terminal A remote-mounting cordset (VW3 A1 104R●●) and an RJ45 adaptor (VW3 A1 105) are also required	7	–	VW3 A1 101	–
Remote-mounting cordsets equipped with 2 RJ45 connectors	8	1	VW3 A1 104R10	0.050
		3	VW3 A1 104R30	0.150
		5	VW3 A1 104R50	0.250
		10	VW3 A1 104R100	0.500
Female/female RJ45 adaptor	9	–	VW3 A1 105	0.010

(1) This terminal may require a software upgrade using the VW3 A8 121 Multi-Loader configuration tool (see page 62083/7).



Configuration with SoMove Mobile software for mobile phones via Bluetooth®

SoMove Mobile software for mobile phones

The SoMove Mobile software converts any compatible mobile phone into a remote graphic display terminal, offering an identical Human-Machine Interface (see page 62083/5).

Particularly suitable for on-site or remote maintenance operations, the SoMove Mobile software can be used to print out and save configurations, import them from a PC and export them to a PC, or to a servo drive equipped with the Modbus adaptor via the Bluetooth® wireless link.

It requires a mobile phone with minimum features, please consult our website www.schneider-electric.com.

The SoMove Mobile software and drive configuration files can be downloaded from our website www.schneider-electric.com.

Reference

Description	Reference	Weight kg
SoMove Mobile software for mobile phones Download from our website www.schneider-electric.com .	–	–
Modbus-Bluetooth® adaptor Enables any non-Bluetooth® device to communicate using this technology.	VW3 A8 114	0.155

- Comprising:
- 1 Bluetooth® adaptor (range 10 m, class 2) with an RJ45 connector
 - For SoMove: 1 x 0.1 m cordset with 2 x RJ45 connectors
 - Etc.(1)

SoMove setup software

The SoMove setup software is used to configure, adjust, debug and maintain the Lexium 32 servo drive, as for all other Schneider Electric variable speed drives and starters.

It communicates via Bluetooth® wireless link with the servo drive, which is equipped with the Modbus-Bluetooth® adaptor (VW3 A8 114).

It can be downloaded from our website www.schneider-electric.com or is available on the “Description of the Motion & Drives Offer” DVD ROM (VW3 A8 200).

For presentation, description and references, see page 60205/2.

(1) Also includes other components for connecting compatible Schneider Electric devices.

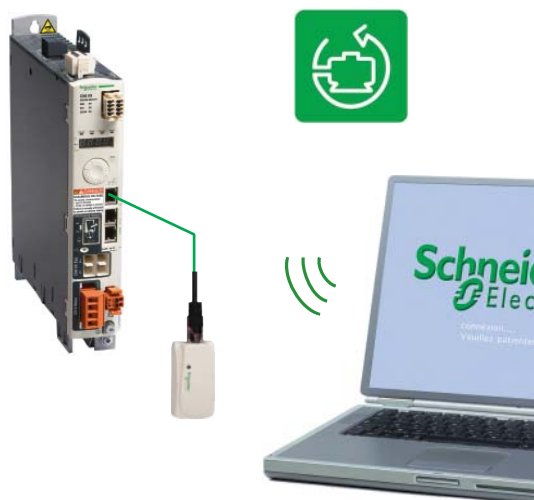

Configuration with the SoMove setup software via Bluetooth®



Configuration of a Lexium 32 in its packaging with the VW3 A8 121 Multi-Loader tool + a VW3 A8 126 cordset

Multi-Loader configuration tool

The Multi-Loader tool enables several configurations to be copied from a PC or a servo drive and loaded onto another servo drive. The Lexium 32 servo drives do not need to be powered up.

References

Description	Reference	Weight kg
Multi-Loader configuration tool Supplied with: <ul style="list-style-type: none"> ■ 1 cordset equipped with 2 RJ45 connectors ■ 1 cordset equipped with one type A USB connector and one mini B USB connector ■ 1 x 2 GB SD memory card ■ 1 x female/female RJ 45 adaptor ■ 4 AA 1.5 V LR6 round batteries 	VW3 A8 121	–

Cordset for Multi-Loader tool

For connecting the Multi-Loader tool to the Lexium 32 servo drive in its packaging.

Equipped with:

- A non-locking RJ45 connector with special mechanical catch on the drive end and
- An RJ45 connector on the Multi-Loader end.

VW3 A8 126

–

Memory card

Description	Reference	Weight kg
Memory card Used to store the parameters of the Lexium 32 servo drive. Another Lexium 32 servo drive can be commissioned immediately in the event of maintenance or duplication.	VW3 M8 705	–
Pack of 25 memory cards	VW3 M8 704	–

Memory card recorder

Writes data from the Lexium 32 servo drive to the memory card.

This recorder is not supplied by Schneider Electric.

See the User's manual

–

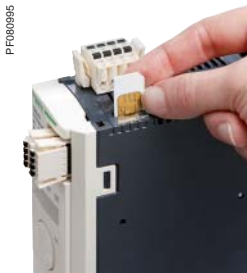

Duplication of an application with the VW3 M8 705 memory card

Connection accessories

Replacement connectors

Designation	For use with	Description	Reference	Weight kg
Set of connectors	Lexium 32C	Comprising: <ul style="list-style-type: none"> ■ 3 connectors for the line supply ■ 1 connector for the DC bus ■ 3 connectors for the I/O ■ 1 connector for the motor power supply ■ 1 connector for the holding brake 	VW3 M2 201	–
	Lexium 32A	Comprising: <ul style="list-style-type: none"> ■ 3 connectors for the line supply ■ 1 connector for the DC bus ■ 2 connectors for the I/O ■ 1 connector for the motor power supply ■ 1 connector for the holding brake 	VW3 M2 202	–
	Lexium 32M	Comprising: <ul style="list-style-type: none"> ■ 3 connectors for the line supply ■ 1 connector for the DC bus ■ 3 connectors for the I/O ■ 1 connector for the motor power supply ■ 1 connector for the holding brake 	VW3 M2 203	–
	Lexium 32 (all types)	Comprising: <ul style="list-style-type: none"> ■ 10 connectors for creating extension cordsets for the DC bus 	VW3 M2 207	–

Cordsets

For use with	Description	Length m	Unit reference	Weight kg
Daisy chain connection of the DC bus	Between 1 Altivar 32 drive (1) and 1 Lexium 32 servo drive: ATV 32H●●●32M2/LXM 32●●●●M2 ATV 32H●●●32N4/LXM 32●●●●N4	0.18	VW3 M7 101R01	–
Daisy chain connection or pulse control	For Lexium 32C and 32M servo drives	0.3	VW3 M8 502R03	0.025
		1.5	VW3 M8 502R15	0.062
	Equipped with 1 RJ45 connector and a free end	3	VW3 M8 223R30	–
Adaptor for motor encoder cable	Replacement of a Lexium 05 servo drive with a Lexium 32 servo drive	–	VW3 M8 111R10	–
	Replacement of a Lexium 15 servo drive with a Lexium 32 servo drive	–	VW3 M8 112R10	–

(1) Variable speed offer, see the "Altivar 32 variable speed drives" catalogue or consult our website www.schneider-electric.com.

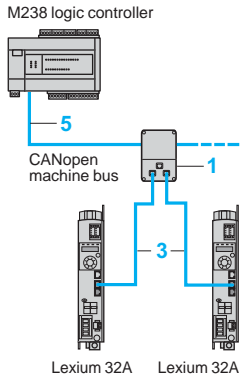

Example of architecture with control by M238 logic controller

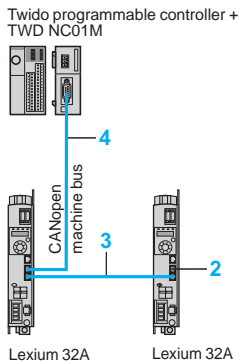

Example of architecture with control by Twido programmable controller

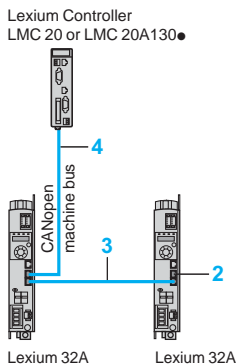

Example of architecture with control by LMC Lexium Controller

CANopen and CANmotion machine bus for Lexium 32A servo drives

Lexium 32A servo drives can be connected directly to the CANopen machine bus using an RJ45 connector. To simplify daisy chain connection, each servo drive is equipped with two connectors of this type (marked CN4 and CN5).

The communication function provides access to the servo drive's configuration, adjustment, control and monitoring functions.

Used with a Lexium Controller motion controller, the CANmotion bus can be used to control motion for applications with up to eight Lexium 32A servo drives.

Connection accessories (1)

Description	Use	Item no.	Reference	Weight kg
IP 20 CANopen tap junction 2 RJ45 ports	Tap-off from trunk cable for RJ45 wiring	1	VW3 CAN TAP2	0.480
Line terminator 120 Ω (equipped with one RJ45 connector)	Connection to the RJ45 connector	2	TCS CAR 013M120	0.009

Cordsets and cables (1)

Description	Use		Item no.	Length m	Reference	Weight kg
	From	To				
CANopen cordsets (1) equipped with 2 RJ45 connectors	VW3 CAN TAP2 junction box	LXM 32A servo drive (CN4 and CN5 connectors)	3	0.3	VW3 CAN CARR03	0.320
	LXM 32A servo drive (CN4 and CN5 connectors)	LXM 32A servo drive (CN4 and CN5 connectors)		1	VW3 CAN CARR1	0.500
CANopen cordsets (1) equipped with one 9-way female SUB-D connector with integrated line terminator and one RJ45 connector	Twido programmable controller	LXM 32A servo drive (CN4 and CN5 connectors)	4	1	VW3 M3 805R010	–
	Motion controller Lexium Controller LMC 20, LMC 20A130●	LXM 32A servo drive (CN4 and CN5 connectors)		3	VW3 M3 805R030	–
CANopen cables (1) Standard cables, C€ marking Low smoke, zero halogen Flame retardant (IEC 60332-1)	PLC	VW3 CAN TAP2 junction box	5	50	TSX CAN CA 50	4.930
				100	TSX CAN CA 100	8.800
				300	TSX CAN CA 300	24.560
CANopen cables (1) UL certification, C€ marking Flame retardant (IEC 60332-2)	PLC	VW3 CAN TAP2 junction box	5	50	TSX CAN CB 50	3.580
				100	TSX CAN CB 100	7.840
				300	TSX CAN CB 300	21.870
CANopen cables (1) Cables for harsh environments (2) or mobile installation, C€ marking Low smoke, zero halogen Flame retardant (IEC 60332-1)	PLC	VW3 CAN TAP2 junction box	5	50	TSX CAN CD 50	3.510
				100	TSX CAN CD 100	7.770
				300	TSX CAN CD 300	21.700

(1) For other CANopen machine bus connection accessories, please consult our website www.schneider-electric.com.

(2) Harsh environment:

- Resistance to hydrocarbons, industrial oils, detergents, solder splashes
- Relative humidity up to 100%
- Saline atmosphere
- Significant temperature variations
- Operating temperature between - 10°C and + 70°C

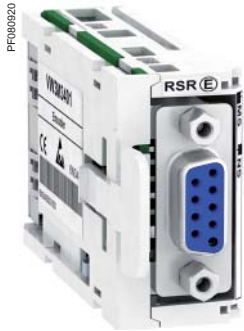

VW3 M3 401 encoder card

Presentation

The Lexium 32M servo drive can take an encoder interface card. This has an input available for an additional encoder, thus offering the following advantages:

- The ability to connect to third-party motors, which increases the installation's flexibility
- The ability to improve positioning accuracy by reducing the effect of mechanical backlash thanks to position measurement directly on the machine, and to meet the requirements of simple applications or complex systems which need a very quick response or very accurate path following

Three cards are available depending on the encoder technology:

- Resolver encoder
- Encoder with digital output
- Encoder with analog output

References

Description	Technology type	Power supply	Encoder type		Reference	Weight
			Machine encoder	Motor encoder		
V ...						kg
Resolver card					VW3 M3 401	-
Encoder interface card with digital output	A/B/I	5			VW3 M3 402	-
	SSI	12				
	BISS	5				
	EnDat 2.2	5				
Encoder interface card with analog output	1 Vpp	5			VW3 M3 403	-
	1 Vpp/Hall	5				
	Hiperface	12				

Connection accessories

Description	Composition	Length m	Reference	Weight kg
Connectors				
Connector 9-way male SUB-D For resolver card	-	-	AEO CON 011	-
Cordset				
Cordset equipped with 1 x 15-way high density male SUB-D connector For card with digital or analog output	-	1	VW3 M4 701	-
Connecting cable				
Cable for creating cordsets for encoder interface cards	[5 x (2 x 0.25 mm ²) + (2 x 0.5 mm ²)]	100	VW3 M8 221R1000	21.000

Osicoder® machine encoders for VW3 M3 402 encoder card

Presentation

To meet requirements for machine encoders, Schneider Electric offers the Osicoder® range of encoders. They connect to the VW3 M3 402 encoder interface card with digital output.

The Osicoder® offer consists of incremental encoders and absolute encoders.

The proposed incremental encoder, with its configurable resolution, satisfies most requirements for machine encoders with A/B/I output signal.

The proposed absolute encoders are among the most commonly used machine encoders with SSI interface.

For more information on the Osicoder® offer, please refer to the "Rotary encoders - Osicoder®" catalogue or our website www.schneider-electric.com.

Ø 58 mm incremental encoder

Operating on the principle of in-line differential optical reading, XCC incremental encoders are extremely rugged, thanks to their technology based on photo-sensitive cells and their triple light source.

The cyclic ratio is maintained even in the event of:

- Failure of one of the sender components
- Reduced efficiency of the sender components (up to 30%)
- Deposit of fine dust on the optical elements

Configurable encoder with Ø 10 mm solid shaft

Resolution	Type of connection	Type of output stage	Supply voltage	Reference	Weight kg
5000...80,000 points	Male M23 radial connector	5 V, RS 422	4.75...30 V	XCC 1510PSM50X	0.465

Note: XCC incremental encoders can also be used as a master encoder on Lexium 32C and Lexium 32M servo drives, when connected to the PTI input.

Ø 58 mm absolute encoders

An absolute encoder continuously delivers a code which is the image of the actual position of the moving part to be controlled. On the first power-up or on return of the power after a power failure, the encoder will deliver a data item which can be used directly by the processing system.

Resolution	Type of connection	Type of output stage	Supply voltage	Reference	Weight kg
8192 points	Male M23 radial connector	SSI, 13 bits, binary	11...30 V	XCC 2510PS81SBN	0.460

Single turn encoder with Ø 10 mm solid shaft

8192 points	Male M23 radial connector	SSI, 13 bits, binary	11...30 V	XCC 2510PS81SBN	0.460
-------------	---------------------------	----------------------	-----------	------------------------	-------

Multiturn encoder with Ø 10 mm solid shaft

8192 points x 4096 turns	Male M23 radial connector	SSI, 25 bits, binary	11...30 V	XCC 3510PS84SBN	0.685
--------------------------	---------------------------	----------------------	-----------	------------------------	-------

PF105184



XCC 1510PSM50X incremental encoder

PF105173



XCC 2510PS81SBN absolute encoder

Presentation

The eSM safety card allows Lexium 32 servo drives to access additional safety functions, as well as the “Safety Torque Off” (STO) function, thus putting in place a complex safety device, while ensuring reliable monitoring of the installation.

The eSM card optimizes the overall cost of the installation by avoiding the addition of external safety products, while conforming to international safety standards. As a result, wiring is cheaper and quicker.

It also improves performance during maintenance by reducing machine or installation downtime and increases the safety of any work carried out.

The eSM card complies with the machinery standard ISO 13849-1, performance level “e” (PL e), functional safety standard IEC/EN 61508, SIL 3 capability, and functional safety standard IEC/EN 62061, SIL 3 capability.

It includes safety functions compliant with standard IEC/EN 61800-5-2.

These functions, required in the majority of applications, are as follows:

- “Safe Torque Off” (STO)
- “Safe Stop 1” (SS1)
- “Safe Stop 2” (SS2)
- “Safe Limited Speed” (SLS)
- “Safe Operating Stop” (SOS)

Safety functions

“Safe Stop 1” (SS1) safety function

The SS1 safety function is used to achieve a category 1 safe stop.

After activation of the function, the servo motor is braked in a controlled manner, maintaining the power on the actuators. The power is then cut when the actuators stop after the machine has come to a halt.

“Safe Stop 2” (SS2) safety function

The SS2 safety function is used to achieve a category 2 safe stop. After activation of the function, the servo motor is braked in a controlled manner, maintaining the power on the actuators. Once the motor has come to a halt, it is kept at a standstill with the “Safe Operating Stop” (SOS) function.

“Safe Limited Speed” (SLS) safety function

The SLS safety function is used to monitor the configured maximum speed. If this speed is exceeded, the servo motor will be stopped in accordance with SS2.

“Safe Operating Stop” (SOS) safety function

The SOS safety function is used to monitor any deviation from the standstill position, once the servo motor has come to a halt.

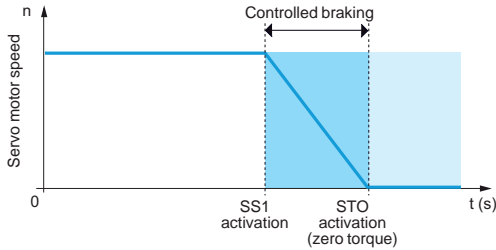

Activation of the “Safe Stop 1” (SS1) safety function

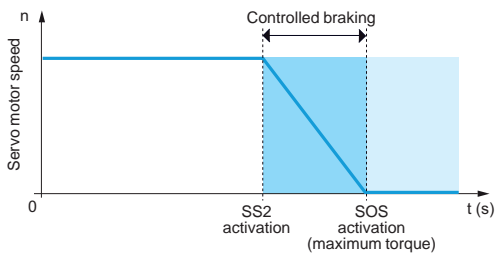

Activation of the “Safe Stop 2” (SS2) safety function

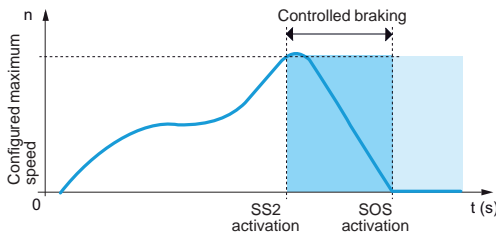

Activation of the “Safe Limited Speed” (SLS) safety function

Lexium 32 motion control

Option: safety card for Lexium 32M servo drives

PF060821

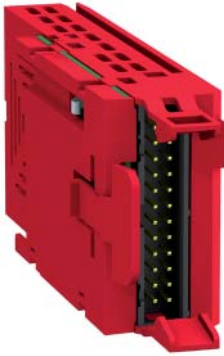

VW3 M3 501 safety card

References

Description	Power supply	Cable length	Unit reference	Weight
	V	m		kg
eSM safety card for Lexium 32M servo drives	24 V (min. 19, max. 30)	–	VW3 M3 501	–
Cordset preassembled with a 24-way female connector (safety card end) and a free end	–	1.5	VW3 M8 801R15	–
		3	VW3 M8 801R30	–
Cordset preassembled with 2 x 24-way female connectors	–	3	VW3 M8 802R30	–
eSM distribution unit equipped with 5 connectors	–	–	VW3 M8 810	–
Removable connector for connecting an additional eSM distribution unit Sold in lots of 4	–	–	VW3 M8 820	–

Presentation

Internal braking resistor

A braking resistor is built into the servo drive to absorb the braking energy. If the DC bus voltage in the servo drive exceeds a specified value, this braking resistor is activated. The restored energy is converted into heat by the braking resistor.
It enables maximum transient braking torque.

External braking resistor

When the servo motor has to be braked frequently, an external braking resistor must be used to dissipate the excess braking energy. In this case, the internal braking resistor must be deactivated.

Several external braking resistors can be connected in parallel.
The servo drive monitors the power dissipated in the braking resistor.

The degree of protection of the casing is IP 65 for VW3 A7 601 R●● to VW3 A7 608 R●● braking resistors and IP 20 for VW3 A7 70● braking resistors.
The operating temperature around the unit can be between 0 and + 50°C.

To optimize the size of the braking resistor, the DC buses on Lexium 32 servo drives in the same installation can be connected in parallel (see 62083/8).

Applications

Machines with high inertia, driving loads and machines with fast cycles.

References

Ohmic value	Continuous power PPr	Peak energy EPk				Length of connection cable	Reference	Weight	
		115 V	230 V	380 V	480 V				
Ω	W	Ws	Ws	Ws	Ws	m		kg	
10	400	18,800	13,300	7300	7700	0.75	VW3 A7 601 R07	1.420	
						2	VW3 A7 601 R20	1.470	
						3	VW3 A7 601 R30	1.620	
	1000	36,500	36,500	22,500	22,500	–	VW3 A7 705	11.000	
15	1000	43,100	43,100	26,500	26,500	–	VW3 A7 704	11.000	
27	100	4200	3800	1900	1700	0.75	VW3 A7 602 R07	0.630	
						2	VW3 A7 602 R20	0.780	
						3	VW3 A7 602 R30	0.900	
	200	9700	7400	4900	4300	0.75	VW3 A7 603 R07	0.930	
						2	VW3 A7 603 R20	1.080	
						3	VW3 A7 603 R30	1.200	
	400	25,500	18,100	11,400	10,500	0.75	VW3 A7 604 R07	1.420	
						2	VW3 A7 604 R20	1.470	
						3	VW3 A7 604 R30	1.620	
	72	100	5500	3700	2500	2300	0.75	VW3 A7 605 R07	0.620
							2	VW3 A7 605 R20	0.750
							3	VW3 A7 605 R30	0.850
200		14,600	9600	6600	6000	0.75	VW3 A7 606 R07	0.930	
						2	VW3 A7 606 R20	1.080	
						3	VW3 A7 606 R30	1.200	
400		36,600	24,700	16,200	15,500	0.75	VW3 A7 607 R07	1.420	
						2	VW3 A7 607 R20	1.470	
						3	VW3 A7 607 R30	1.620	
100	100	4400	4400	2900	2900	0.75	VW3 A7 608 R07	0.410	
						2	VW3 A7 608 R20	0.560	
						3	VW3 A7 608 R30	0.760	

Note: The total continuous power dissipated in the external braking resistor(s) must be less than or equal to the nominal power of the Lexium 32 servo drive (see pages 62083/2 and 62083/3).



VW3 A7 60● R●●



VW3 A7 70●

Presentation

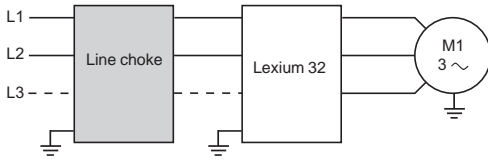

A line choke can be used to provide improved protection against overvoltages on the line supply and to reduce harmonic distortion of the current produced by the servo drive.

The recommended chokes limit the line current. They have been developed in line with standard IEC 61800-5-1 (VDE 0160 level 1 high-energy overvoltages on the line supply).

The inductance values are defined for a voltage drop between 3% and 5% of the nominal line voltage. Values higher than this will cause loss of torque.

These chokes must be installed upstream of the servo drive. One line choke can be connected to a number of servo drives. In such cases, the current consumption of all the servo drives at nominal voltage must not exceed the nominal current of the line choke.

The use of line chokes is recommended in particular under the following circumstances:

- Close connection of several servo drives in parallel
- Line supply with significant disturbance from other equipment (interference, overvoltages)
- Line supply with voltage unbalance between phases that is more than 1.8% of the nominal voltage
- Servo drive supplied by a line with very low impedance (in the vicinity of a power transformer 10 times more powerful than the servo drive rating)
- Installation of a large number of servo drives on the same line
- Reduction of overloads on the $\cos \varphi$ correction capacitors, if the installation includes a power factor correction unit.

References

For servo drive	Inductance value	Losses	Line current and THD				Reference	Weight
			Without choke		With choke			
			mH	W	A	%		
Single-phase supply voltage: 115 V ~ 50/60 Hz								
LXM 32•U45M2	5	20	2.9	173	2.6	85	VZ1 L007UM50	0.880
LXM 32•U90M2	2	30	5.4	159	5.2	90	VZ1 L018UM20	1.990
LXM 32•D18M2	2	30	8.5	147	9.9	74		
LXM 32•D30M2	2	30	12.9	135	9.9	72		
Single-phase supply voltage: 230 V ~ 50/60 Hz								
LXM 32•U45M2	5	20	2.9	181	3.4	100	VZ1 L007UM50	0.880
LXM 32•U90M2	2	30	4.5	166	6.3	107	VZ1 L018UM20	1.990
LXM 32•D18M2	2	30	8.4	148	10.6	93		
LXM 32•D30M2	2	30	12.7	135	14.1	86		
Three-phase supply voltage: 380 V ~ 50/60 Hz								
LXM 32•U60N4	2	75	1.4	187	1.9	106	VW3 A4 553	3.500
LXM 32•D12N4	2	75	3	174	3.5	88		
LXM 32•D18N4	1	90	5.5	159	7.2	88	VW3 A4 554	6.000
LXM 32•D30N4	1	90	8.7	146	11.6	74		
LXM 32•D72N4	1	90	18.1	124	23.5	43		
Three-phase supply voltage: 480 V ~ 50/60 Hz								
LXM 32•U60N4	2	75	1.2	201	1.6	116	VW3 A4 553	3.500
LXM 32•D12N4	2	75	2.4	182	2.9	98		
LXM 32•D18N4	1	90	4.5	165	6	98	VW3 A4 554	6.000
LXM 32•D30N4	1	90	7	152	9.6	85		
LXM 32•D72N4	1	90	14.6	129	19.5	55		

Lexium 32 motion control

Integrated EMC filters and additional EMC input filters for servo drives

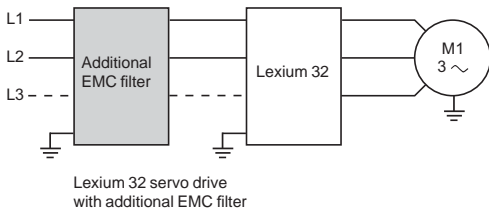
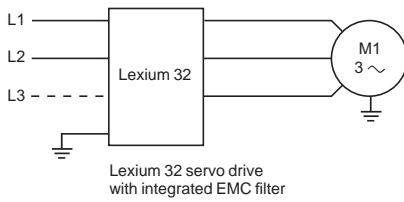

Additional EMC filter mounted on a Lexium 32M servo drive

Integrated EMC filter

Function

Lexium 32 servo drives have integrated radio interference input filters to comply with the EMC standard for variable speed electrical power drive “products” IEC/EN 61800-3, edition 2, category C3 in environment 2, and to comply with the European directive on EMC (electromagnetic compatibility).

For servo drive

Maximum servo motor cable length conforming to EN 55011, class A, Gr2 IEC/EN 61800-3, category C3 in environment 2 (1)
Switching frequency: 8 kHz

m

Single-phase supply voltage: 115 V ~ 50/60 Hz

LXM 32●●●●M2 20 (10 metres in category C2, environment 1)

Single-phase supply voltage: 230 V ~ 50/60 Hz

LXM 32●●●●M2 20 (10 metres in category C2, environment 1)

Three-phase supply voltage: 380 V ~ 50/60 Hz

LXM 32●●●●N4 20

Three-phase supply voltage: 480 V ~ 50/60 Hz

LXM 32●●●●N4 20

Additional EMC input filters

Applications

Used with Lexium 32 servo drives, additional EMC input filters can be used to meet more stringent requirements and are designed to reduce conducted emissions on the line supply below the limits of standard IEC/EN 61800-3 edition 2, category C2 or C3 (see page 62094/9).

Additional EMC filters are mounted on the side of the device. They have tapped holes for mounting in an enclosure.

Use according to the type of line supply

Integrated or additional EMC filters can only be used on TN (neutral connection) or TT (neutral to earth) systems.

Lexium 32 servo drives cannot be used on IT (impedance earthed or isolated neutral) systems. Standard IEC/EN 61800-3, appendix D2.1, states that on IT systems, filters can cause permanent insulation monitors to operate in a random manner.

If a machine has to be installed on an IT system, an isolation transformer must be inserted in order to re-create a TT system on the secondary side.

(1) Standard IEC/EN 61800-3: EMC immunity and conducted and radiated EMC emissions: - Category C3 in environment 2: industrial premises.

PF096115



VW3 A4 422

References				
For servo drive	Maximum servo motor shielded cable length conforming to		Reference	Weight
	EN 55011 class A Gr1	EN 55011 class A Gr2		
	IEC/EN 61800-3 category C2 (1) in environment 1	IEC/EN 61800-3 category C3 (1) in environment 2		
	Switching frequency 8 kHz	Switching frequency 8 kHz		
	m	m		kg
Single-phase supply voltage				
LXM 32●U45M2 LXM 32●U90M2	50	100	VW3 A4 420	0.600
LXM 32●D18M2 LXM 32●D30M2	50	100	VW3 A4 421	0.775
Three-phase supply voltage				
LXM 32●U60N4 LXM 32●D12N4 LXM 32●D18N4 LXM 32●D30N4	50	100	VW3 A4 422	0.900
LXM 32●D72N4	50	100	VW3 A4 423	1.350

(1) Standard IEC/EN 61800-3: EMC immunity and conducted and radiated EMC emissions:
 - Category C2 in environment 1: restricted distribution, for domestic use, sale conditional on the competence of the user and the distributor in terms of reduction of current harmonics
 - Category C3 in environment 2: industrial premises.

Lexium 32 motion control

Communication buses and networks

CANopen/CANmotion machine bus

Lexium 32A servo drives integrate the CANopen communication protocol as standard (see page 62083/9).

If one of the communication cards (available as options) is added, the Lexium 32M servo drive can be connected to the following communication buses and networks:

- CANopen and CANmotion machine bus
- PROFIBUS DP V1 fieldbus
- DeviceNet fieldbus
- EtherNet/IP network
- EtherCAT fieldbus

The Lexium 32M servo drive can only take one communication card.

CANopen and CANmotion machine bus

Presentation

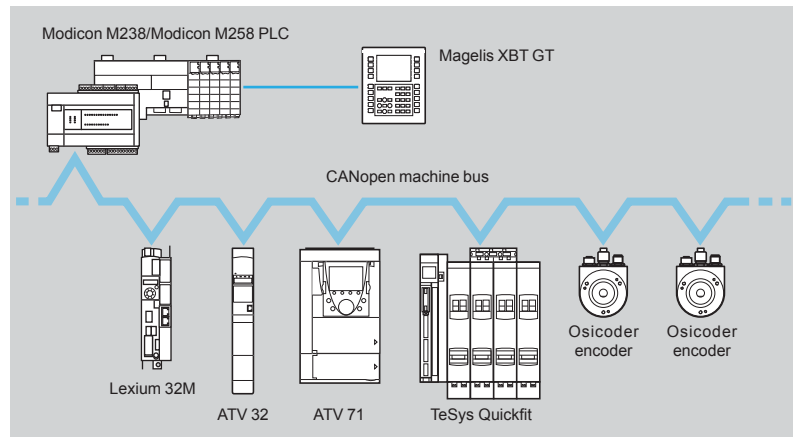

Installing the CANopen communication card VW3 A3 608

The CANopen machine bus is specifically designed for integration in control system architectures. It provides openness and interoperability for various devices (drives, motor starters, smart sensors, etc.).

A tiered CANopen connectivity solution reduces costs and optimizes the creation of the control system architecture, providing:

- Reduced cabling time
- Greater reliability of the load
- Flexibility should you need to add or remove equipment

It is very easy to set up.

The same communication card provides access to either the CANopen or CANmotion machine bus. The characteristics of the cards are available on our website www.schneider-electric.com.

An optimized solution for connection to the CANopen/CANmotion machine bus

To simplify the setup of Lexium 32M servo drives, three communication cards are available, each with different connectors:

- CANopen/CANmotion Daisy chain card with connection to the bus via two RJ45 connectors, providing an optimized solution for daisy chain connection to the CANopen machine bus (see page 62084/3)
- CANopen/CANmotion card with connection to the bus via screw terminals (see page 62084/3)
- CANopen/CANmotion card with connection to the bus via 9-way male SUB-D connector (see page 62084/4)

CANopen/CANmotion machine bus: connection via RJ45 connector

CANopen/CANmotion Daisy Chain communication card

Description	Type of port	Item no.	Unit reference	Weight kg
CANopen/CANmotion Daisy Chain card for Lexium 32M servo drives	2 RJ45 connectors	1	VW3 A3 608	-

Connection accessories for VW3 A3 608 CANopen Daisy Chain card

CANopen line terminator (1)	With RJ45 connector	2	TCS CAR 013M120	0.009
CANopen IP 20 junction boxes	2 RJ45 connectors	-	VW3 CAN TAP2	0.250

Cordsets for VW3 A3 608 CANopen/CANmotion Daisy Chain card

Description	Use		Item no.	Length m	Reference	Weight kg
	From	To				
CANopen cordsets equipped with one RJ45 connector at each end	LXM 32A servo drive	VW3 A3 608 card	3	0.3	VW3 CAN CARR03	0.320
	LXM 32M servo drive	LXM 32A servo drive				
CANopen cordsets equipped with one 9-way female SUB-D connector with integrated line terminator and one RJ45 connector	VW3 A3 608 card	VW3 A3 608 card	4	1	VW3 M3 805R010	-
	VW3 CAN TAP2 junction box	LXM 32A servo drive				
CANopen cordsets equipped with one 9-way female SUB-D connector with integrated line terminator and one RJ45 connector	Lexium Controller: LMC 20	LXM 32M servo drive	3	3	VW3 M3 805R030	-
	Lexium Controller: LMC 20A130	LXM 32M servo drive				

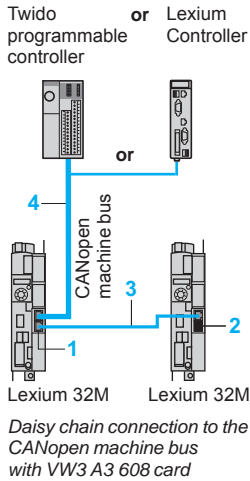

CANopen/CANmotion machine bus: connection via screw terminals

CANopen/CANmotion communication card

Description	Type of port	Item no.	Unit reference	Weight kg
CANopen/CANmotion card for Lexium 32M servo drives	One 5-way screw terminal block	1	VW3 A3 628	-

Connection accessory for VW3 A3 628 CANopen/CANmotion communication card

CANopen line terminator (1)	Stripped wires for screw terminal connector	2	TCS CAR 013M120	-
-----------------------------	---------------------------------------------	---	-----------------	---

Connection cables for VW3 A3 628 CANopen/CANmotion communication card

Description	Use		Item no.	Length m	Reference	Weight kg
	From	To				
CANopen cables Standard cables, C€ marking Low smoke zero halogen Flame retardant (IEC 60332-1)	Programmable controller	VW3 A3 628 card	3	50	TSX CAN CA 50	4.930
				100	TSX CAN CA 100	8.800
				300	TSX CAN CA 300	24.560
CANopen cables UL certification, C€ marking Flame retardant (IEC 60332-2)	Programmable controller	VW3 A3 628 card	3	50	TSX CAN CB 50	3.580
				100	TSX CAN CB 100	7.840
				300	TSX CAN CB 300	21.870
CANopen cables Cable for harsh environment (3) or mobile installation, C€ marking Low smoke zero halogen Flame retardant (IEC 60332-1)	Programmable controller	VW3 A3 628 card	3	50	TSX CAN CD 50	3.510
				100	TSX CAN CD 100	7.770
				300	TSX CAN CD 300	21.700

(1) Order in lots of 2.

(2) Cable dependent on the type of controller or PLC; please refer to the corresponding catalogue.

(3) Harsh environment:

- resistance to hydrocarbons, industrial oils, detergents, solder splashes,
- relative humidity up to 100%,
- saline atmosphere,
- significant temperature variations, operating temperature between - 10°C and + 70°C.



VW3 A3 628 CANopen communication card

Modicon M328/Modicon M258 PLC

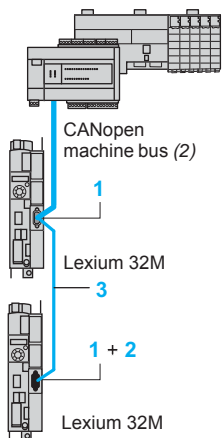

Example of connection to the CANopen machine bus with VW3 A3 628 card



VW3 A3 618 CANopen communication card

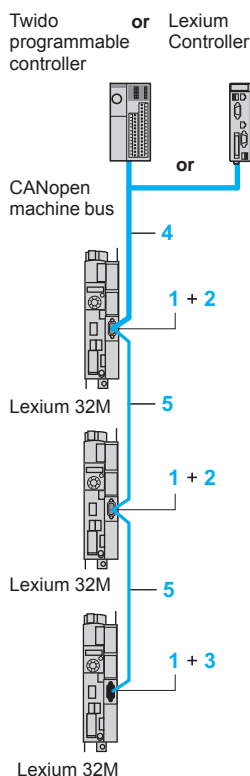

Example of connection to the CANopen machine bus with VW3 A3 618 card

CANopen/CANmotion machine bus: connection via SUB-D connector

CANopen/CANmotion communication card

Description	Type of port	Item no.	Reference	Weight kg
CANopen/CANmotion card for Lexium 32M servo drives	One 9-way male SUB-D connector	1	VW3 A3 618	—

Connection accessories for VW3 A3 618 CANopen/CANmotion card

Description	Type of port	Item no.	Unit reference	Weight kg
9-way female SUB-D connector with screw terminals. Line termination switch that can be deactivated	—	2	VW3 M3 802	—

CANopen line terminator (1)	Stripped wires for screw terminal connector	3	TCS CAR 01NM120	—
-----------------------------	---------------------------------------------	---	-----------------	---

CANopen IP20 connectors, 9-way female SUB-D Line termination switch that can be deactivated	Straight	—	TSX CAN KCDF180T	0.049
	Angled at 90°	—	TSX CAN KCDF90T	0.046
	Angled at 90° with 9-way SUB-D for connecting PC or diagnostics tool	—	TSX CAN KCDF90TP	0.051

Cordsets for VW3 A3 618 CANopen/CANmotion card

Description	Use		Item no.	Length m	Reference	Weight kg
	From	To				
CANopen IP 20 cordsets equipped with one 9-way female SUB-D 9 connector at each end. Standard cables, CE marking Low smoke zero halogen Flame retardant (IEC 60332-1)	Lexium Controller: LMC 20	VW3 A3 618 card	4	0.3	TSX CAN CADD 03	0.091
	LMC 20	LMC 20A130	—	1	TSX CAN CADD 1	0.143
	—	—	—	3	TSX CAN CADD 3	0.295
	—	—	—	5	TSX CAN CADD 5	0.440

CANopen IP 20 cordsets equipped with one 9-way female SUB-D 9 connector at each end. Standard cables, UL certification, CE marking Flame retardant (IEC 60332-2)	Lexium Controller: LMC 20	VW3 A3 618 card	4	0.3	TSX CAN CBDD 03	0.086
	LMC 20	LMC 20A130	—	1	TSX CAN CBDD 1	0.131
	—	—	—	3	TSX CAN CBDD 3	0.268
	—	—	—	5	TSX CAN CBDD 5	0.400

CANopen/CANmotion machine bus: other connection accessories

Description	Use		Item no.	Length m	Reference	Weight kg
	From	To				
CANopen cables Standard cables, CE marking Low smoke zero halogen Flame retardant (IEC 60332-1)	VW3 M3 802 connector	VW3 M3 802 connector	5	50	TSX CAN CA 50	4.930
	TSX CAN KCDF90T connector	TSX CAN KCDF90T connector	—	100	TSX CAN CA 100	8.800
	M238 logic controller	M238 logic controller	—	300	TSX CAN CA 300	24.560

CANopen cables UL certification, CE marking Flame retardant (IEC 60332-2)	VW3 M3 802 connector	VW3 M3 802 connector	5	50	TSX CAN CB 50	3.580
	TSX CAN KCDF90T connector	TSX CAN KCDF90T connector	—	100	TSX CAN CB 100	7.840
	M238 logic controller	VW3 CAN TAP2 junction box	—	300	TSX CAN CB 300	21.870

CANopen cables Cable for harsh environment (2) or mobile installation, CE marking Low smoke zero halogen Flame retardant (IEC 60332-1)	VW3 M3 802 connector	VW3 M3 802 connector	5	50	TSX CAN CD 50	3.510
	TSX CAN KCDF90T connector	TSX CAN KCDF90T connector	—	100	TSX CAN CD 100	7.770
	M238 logic controller	VW3 CAN TAP2 junction box	—	300	TSX CAN CD 300	21.700

(1) Order in lots of 2.

(2) Harsh environment:

- resistance to hydrocarbons, industrial oils, detergents, solder splashes,
- relative humidity up to 100%,
- saline atmosphere,
- significant temperature variations, operating temperature between - 10°C and + 70°C.

PROFIBUS DP V1 fieldbus

Presentation

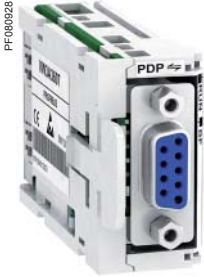

VW3 A3 607 PROFIBUS DP V1 communication card

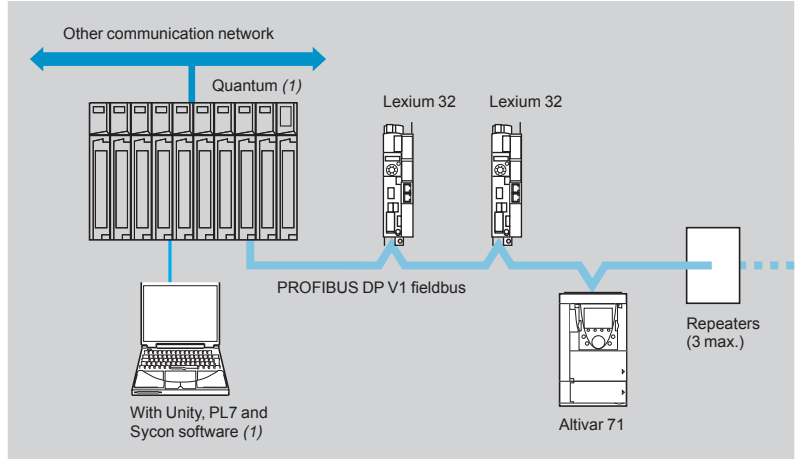

PROFIBUS DP is a fieldbus for industrial communication.

The Lexium 32M servo drive is connected to the PROFIBUS DP V1 fieldbus via the VW3 A3 607 communication card.

Other devices can be connected to the PROFIBUS DP V1 bus such as PLCs (1), STB I/O (2), Altivar variable speed drives (3), Osicoder rotary encoders (4), etc.

Reference

Description	For use with	Type of port	Reference	Weight kg
PROFIBUS DP V1 card	Lexium 32M servo drives	One 9-way female SUB-D connector	VW3 A3 607	0.140

DeviceNet fieldbus

Presentation



VW3 M3 301 DeviceNet communication card

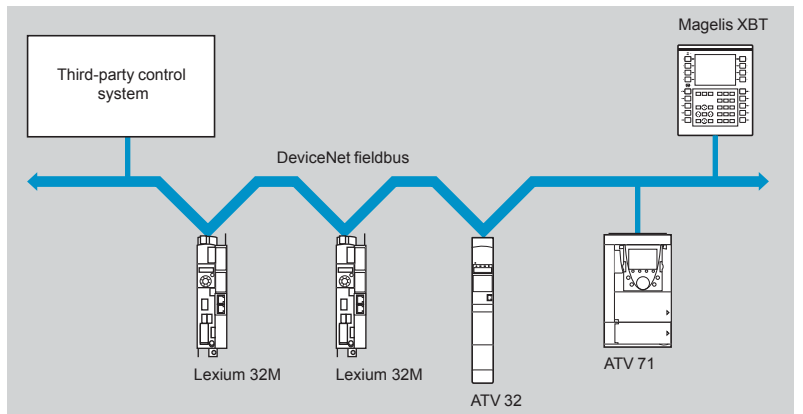

The DeviceNet fieldbus is used in industry to manage a large number of devices remotely.

Connection to the DeviceNet fieldbus allows Lexium 32M servo drives to standardize motion control solutions, while remaining independent of the system controlling the machine.

Reference

Description	For use with	Type of port	Profiles supported	Reference	Weight kg
DeviceNet card	Lexium 32M servo drive	One removable screw connector, 5 contacts with 5.08 pitch	CIP motion profile Profile compatible with PLCOpen libraries	VW3 M3 301	–

1) Please refer to the "Automation platform Modicon Quantum and Unity" catalogue or our website www.schneider-electric.com.

2) Please refer to the "Human-Machine interfaces" catalogue or our website www.schneider-electric.com.

3) Please refer to the "Altivar ... variable speed drives" catalogue or our website www.schneider-electric.com.

4) Please refer to the "Global Detection" catalogue or our website www.schneider-electric.com.

EtherNet/IP network

Presentation

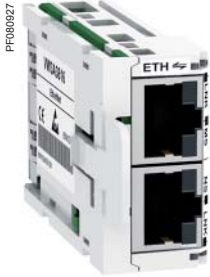

VW3 A3 616 EtherNet/IP communication card

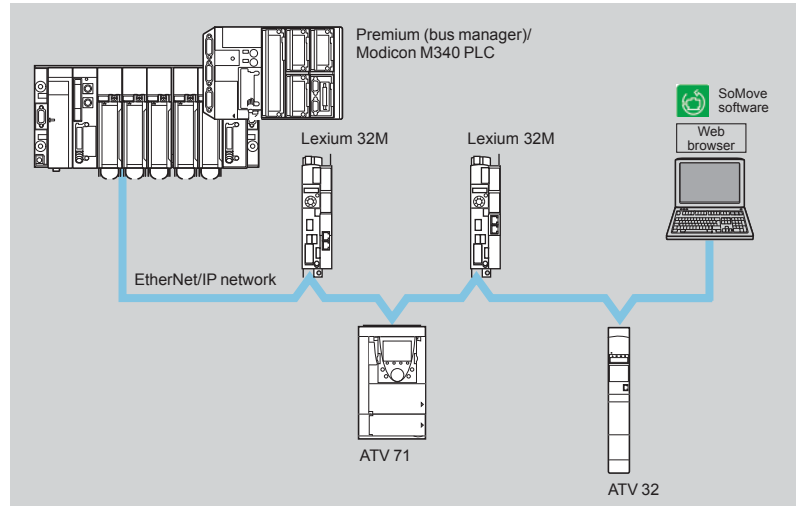

The EtherNet/IP network is a protocol specially designed for industrial environments. It uses the widely implemented Ethernet protocols: TCP (Transmission Control Protocol) and IP (Internet Protocol), thus offering an integrated transparent connection system to the company network.

Thanks to its high speed, the network no longer restricts the application's performance.

It is the pre-eminent open protocol and supports all types of communication:

- Web pages
- File transfers
- Messaging

Reference

Description	For use with	Type of port	Reference	Weight kg
EtherNet/IP card ■ 10/100 Mbps, half and full duplex ■ Embedded Web server	Lexium 32M servo drives	2 RJ45 connectors	VW3 A3 616	0.300

EtherNet/IP network connection accessories

Description	Type of port	Length m (1)	Reference	Weight kg
ConneXium cordsets (conforming to EIA/TIA-568, category 5 and IEC1180/EN50173, class D, standards)				
Straight shielded twisted pair cordsets	2 RJ45 connectors	2	490 NTW 000 02	—
		5	490 NTW 000 05	—
		12	490 NTW 000 12	—
Crossed shielded twisted pair cordsets	2 RJ45 connectors	5	490 NTC 000 05	—
		15	490 NTC 000 15	—
ConneXium cordsets (conforming to UL and CSA 22.1 standards)				
Straight shielded twisted pair cordsets	2 RJ45 connectors	2	490 NTW 000 02U	—
		5	490 NTW 000 05U	—
		15	490 NTW 000 12U	—
Crossed shielded twisted pair cordsets	2 RJ45 connectors	5	490 NTC 000 05U	—

(1) Also available in 40 and 80 metre lengths.

To order other ConneXium connection components, please refer to our website www.schneider-electric.com.

EtherCAT fieldbus

Presentation

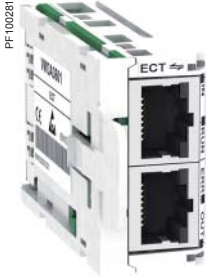

VW3 A3 601 EtherCAT communication card

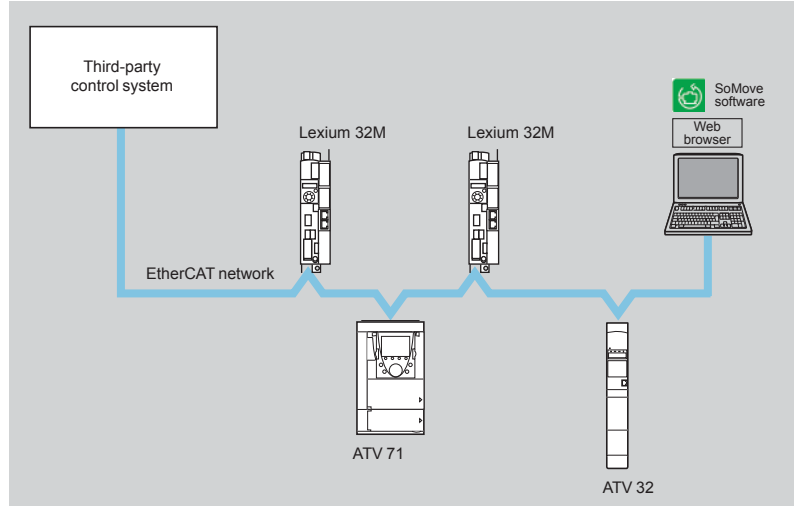

EtherCAT (EtherNet for Control Automation Technology) is an open fieldbus whose technology is based on EtherNet. As a result, all EtherNet technologies can be used in the EtherCAT environment: embedded Web server, e-mail, FTP transfer, etc.

The EtherCAT fieldbus is intended for applications requiring very short cycle times ($\leq 250 \mu\text{s}$) with low jitter ($\leq 1 \mu\text{s}$) for perfect synchronization.

These characteristics enable the EtherCAT network to achieve very high performance levels in the control systems field, with low equipment costs.

Reference				
Description	For use with	Type of port	Reference	Weight kg
EtherCAT card	Lexium 32M servo drives	2 RJ45 connectors	VW3 A3 601	0.300

EtherCAT fieldbus connection accessories				
Description	Type of port	Length m (1)	Reference	Weight kg
ConneXium cordsets (conforming to EIA/TIA-568, category 5, and IEC1180/EN50173, class D, standards)				
Straight shielded twisted pair cordsets	2 RJ45 connectors	2	490 NTW 000 02	—
		5	490 NTW 000 05	—
		12	490 NTW 000 12	—
Crossed shielded twisted pair cordsets	2 RJ45 connectors	5	490 NTC 000 05	—
		15	490 NTC 000 15	—
ConneXium cordsets (conforming to UL and CSA 22.1 standards)				
Straight shielded twisted pair cordsets	2 RJ45 connectors	2	490 NTW 000 02U	—
		5	490 NTW 000 05U	—
		15	490 NTW 000 12U	—
Crossed shielded twisted pair cordsets	2 RJ45 connectors	5	490 NTC 000 05U	—

(1) Also available in 40 and 80 metre lengths.

To order other ConneXium connection components, please refer to our website www.schneider-electric.com.



SoMove start page

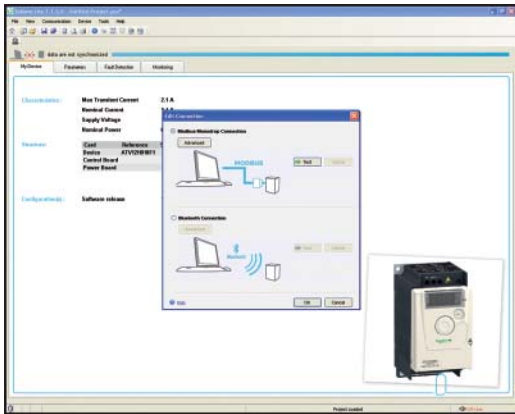

Example of connecting SoMove software to an ATV 12 drive

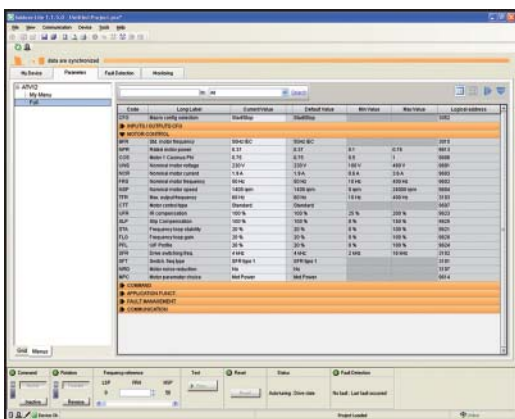

SoMove control panel

Presentation

SoMove is user-friendly setup software for PCs, for setting up the following Schneider Electric motor control devices:

- ATV 12, ATV 312, ATV 31, ATV 32, ATV 61 and ATV 71 variable speed drives
- ATS 22 starters
- TeSys U starter-controllers
- TeSys T motor management system
- Lexium 32 servo drives

SoMove software incorporates various functions for the device setup phases, such as:

- Configuration preparation
- Start-up
- Maintenance

To facilitate setup and maintenance, SoMove software can use a direct USB/RJ45 cable link or a Bluetooth® wireless link.

SoMove software is also compatible with the Multi-Loader configuration tool and SoMove Mobile software for mobile phones.

These tools can save a significant amount of time when loading, duplicating or editing configurations on a device.

SoMove software and all the DTMs (Device Type Managers) associated with the devices can be downloaded from our website www.schneider-electric.com.

Functions

Configuration preparation in disconnected mode

SoMove software has a genuine disconnected mode which provides access to all the device parameters. This mode can be used to generate the device configuration. The configuration can be saved, printed and exported to office automation software.

SoMove software also checks the consistency of the parameters, validating the configurations created in disconnected mode.

A large number of functions are available in disconnected mode, in particular:

- The device configuration software wizard
- The configuration comparison wizard
- Saving, copying, printing and creating configuration files for export to Multi-Loader, SoMove Mobile or Microsoft Excel® and sending configurations by e-mail.

Setup

When the PC is connected to the device, SoMove software can be used for:

- Transferring the configuration that has been generated onto the device
- Adjustment and monitoring. This includes such functions as:
 - The oscilloscope
 - Displaying communication parameters
- Easy control via the control panel user interface
- Saving the final configuration

Maintenance

In order to simplify maintenance operations, SoMove software can be used to:

- Compare the configuration of a device currently being used with a configuration saved on the PC
- Transfer a configuration to a device
- Compare oscilloscope curves
- Save oscilloscope curves and faults

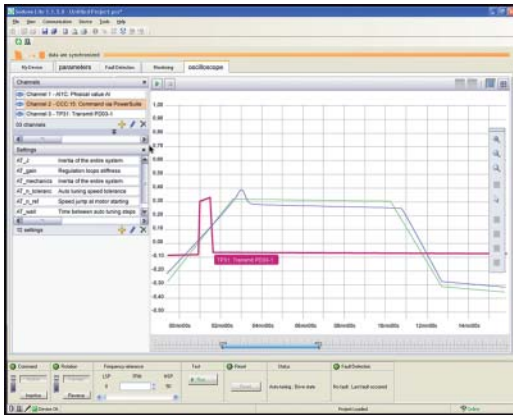

SoMove oscilloscope function

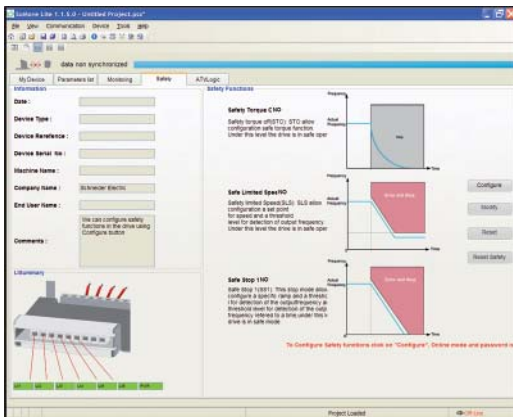

SoMove Safety function

Functions (continued)

User interface

SoMove software provides fast, direct access to all information on the device via five tabs:

- **My Device:** Displays all the information on the device (type, reference, software versions, option cards, etc.)
- **Parameters:** Displays all the device adjustment parameters, shown in a table or in the form of diagrams
- **Faults:** Displays a list of the faults that may be encountered with the device, the fault log and any current faults or alarms
- **Monitoring:** Provides a realtime display of the device status, its I/O and all the monitoring parameters. It is possible to create your own control panel by selecting your parameters and how they are to be represented.
- **Oscilloscope:** Provides a high-speed oscilloscope (recording traces in the device) or low-speed oscilloscope (recording traces in the software for devices that do not have an integrated oscilloscope)

SoMove's user interface automatically adapts to the specific configured device by offering additional tabs:

- **Safety:** For configuring the Safety functions on ATV 32 variable speed drives and Lexium 32 servo drives. It can also be used to:
 - Display the I/O
 - Compile and print a report
 - **ATVLogic:** For accessing the ATV 32 drive's programmable function blocks. It can also be used to:
 - Develop a program and transfer it to the drive
 - Display and debug the program already on the drive
 - **Auto-tuning:** For accessing the servo control settings for the three different operating modes of the Lexium 32 servo drive's auto-tuning function:
 - Automatic mode for quick setup, designed for simple applications
 - Semi-automatic mode for quick setup, with the option of optimizing the servo drive/servo motor combination (access to the mechanical and dynamic behaviour parameters)
 - Expert mode for optimizing the adjustment parameters, designed for complex applications

Connections

Modbus serial link

The PC running SoMove software can be connected directly via the RJ45 connector on the device and the USB port on the PC using the USB/RJ45 cable.

See the product references on page 60205/4.

Bluetooth® wireless link

SoMove software can communicate via Bluetooth® wireless link with any Bluetooth® enabled device.

If the device is not Bluetooth® enabled, use the Modbus-Bluetooth® adaptor. This adaptor is connected to the terminal port or the Modbus network port on the device. It has a 10 m range (class 2).

If the PC is not Bluetooth® enabled, use the USB-Bluetooth® adaptor.

See the product references on page 60205/4.



SoMove setup software



VW3 A8 114:
Bluetooth® adaptor

References

Description	Reference	Weight kg
SoMove lite setup software Comprising: <ul style="list-style-type: none"> ■ SoMove setup software for PC in English, French, German, Italian, Spanish and Chinese ■ DTMs (Device Type Managers) and technical documentation for variable speed drives, starters and servo motors 	(1)	–
USB/RJ45 cable Used to connect a PC to the device. This cable is 2.5 m long, and has a USB connector (PC end) and an RJ45 connector (device end).	TCSM CNAM 3M002P	–
Modbus-Bluetooth® adaptor Used to enable any non-Bluetooth® device to communicate via Bluetooth® wireless link (2). Comprising: <ul style="list-style-type: none"> ■ 1 Bluetooth® adaptor (range 10 m, class 2) with an RJ45 connector ■ For SoMove: 1 x 0.1 m cable with 2 x RJ45 connectors ■ For TwidoSuite: 1 x 0.1 m cable with 1 RJ45 connector and 1 mini DIN connector 	VW3 A8 114	0.155
USB-Bluetooth® adaptor for PC Used to enable any non-Bluetooth® PC to communicate via Bluetooth® wireless link (3). It connects to a USB port on the PC. Range 10 m (class 2)	VW3 A8 115	0.290

(1) Available on our website www.schneider-electric.com

(2) Required for the following devices:

- ATV 12, ATV 312, ATV 31, ATV 61 and ATV 71 drives
- ATS 22 starters
- TeSys U starter-controllers
- TeSys T motor management system
- Lexium 32 servo drives

(3) Check the manufacturer's specification.

Compatibility of SoMove software with specific devices

Device	Range	Version of software on the device
Variable speed drive	ATV 12, ATV 312, ATV 32	≥ 1.0
	ATV 31	≥ 1.1
	ATV 61, ATV 71	≥ 1.6
Starter	ATS 22	≥ 1.0
Starter-controller	TeSys U	≥ 1.0
Motor management system	TeSys T	≥ 1.0
Servo drive	Lexium 32	≥ 1.0

Environments

SoMove operates in the following PC environments and configurations:

- Microsoft Windows® 7 Professional (1)
- Microsoft Windows® XP Professional SP3
- Microsoft Windows® Vista Business SP2
- Pentium IV (or equivalent), 1 GHz, hard disk with 1 GB available space, 1 GB of RAM (minimum configuration)

(1) Please contact our Customer Care Centre.

Applications

The combinations listed below can be used to create a complete motor starter unit comprising a contactor and a Lexium 32 servo drive.

The contactor turns on and manages any safety features, as well as isolating the servo motor on stopping.

The servo drive controls the servo motor, provides protection against short-circuits between the servo drive and the servo motor and protects the motor cable against overloads. The overload protection is provided by the motor thermal protection of the servo drive.



+



LC1 D18●●
+
LXM 32MD30M2

Motor starters for Lexium 32 servo drives

Servo drive		Max. prospective line Isc	Contactor
Reference	Nominal power		Reference (1) (2)
	kW	kA	
Single-phase supply voltage: 100...120 V ~ 50/60 Hz			
LXM 32●U45M2	0.15	1	LC1 D09●●
LXM 32●U90M2	0.3	1	LC1 D09●●
LXM 32●D18M2	0.5	1	LC1 D12●●
LXM 32●D30M2	0.8	1	LC1 D18●●

Single-phase supply voltage: 200...240 V ~ 50/60 Hz			
LXM 32●U45M2	0.3	1	LC1 D09●●
LXM 32●U90M2	0.5	1	LC1 D09●●
LXM 32●D18M2	1	1	LC1 D12●●
LXM 32●D30M2	1.6	1	LC1 D18●●

Three-phase supply voltage: 400 V ~ 50/60 Hz			
LXM 32●U60N4	0.4	5	LC1 D09●●
LXM 32●D12N4	0.9	5	LC1 D09●●
LXM 32●D18N4	1.8	5	LC1 D09●●
LXM 32●D30N4	3	5	LC1 D12●●
LXM 32●D72N4	7	5	LC1 D25●●

Three-phase supply voltage: 480 V ~ 50/60 Hz			
LXM 32●U60N4	0.4	5	LC1 D09●●
LXM 32●D12N4	0.9	5	LC1 D09●●
LXM 32●D18N4	1.8	5	LC1 D09●●
LXM 32●D30N4	3	5	LC1 D12●●
LXM 32●D72N4	7	5	LC1 D25●●

(1) Composition of contactors:

LC1 D●●: 3 poles + 1 "N/O" auxiliary contact and 1 "N/C" auxiliary contact.

In certain situations, it is possible to use an LC1 K contactor with 1 "N/C" auxiliary contact.

Please refer to the "Control and protection components" catalogue.

(2) Replace ●● with the control circuit voltage reference given in the table below:

	Volts ~	24	48	110	220/230	230	230/240
LC1 D●●	50 Hz	B5	E5	F5	M5	P5	U5
	50 Hz	B6	E6	F6	M6	–	U6
	50/60 Hz	B7	E7	F7	M7	P7	U7

For other available voltages between 24 V and 660 V, or for a DC control circuit, please consult your customer care centre.

Protection using class J fuses (UL standard)		
Servo drive		Fuse to be placed upstream
Reference	Nominal power kW	A
Single-phase supply voltage: 100...120 V ~ 50/60 Hz		
LXM 32●U45M2	0.15	4
LXM 32●U90M2	0.3	6
LXM 32●D18M2	0.5	10
LXM 32●D30M2	0.8	15
Single-phase supply voltage: 200...240 V ~ 50/60 Hz		
LXM 32●U45M2	0.3	4
LXM 32●U90M2	0.5	6
LXM 32●D18M2	1	10
LXM 32●D30M2	1.6	15
Three-phase supply voltage: 400 V ~ 50/60 Hz		
LXM 32●U60N4	0.4	2
LXM 32●D12N4	0.9	4
LXM 32●D18N4	1.8	8
LXM 32●D30N4	3	10
LXM 32●D72N4	7	20
Three-phase supply voltage: 480 V ~ 50/60 Hz		
LXM 32●U60N4	0.4	2
LXM 32●D12N4	0.9	3
LXM 32●D18N4	1.8	8
LXM 32●D30N4	3	10
LXM 32●D72N4	7	20



BMH servo motor with straight connectors



BMH servo motor with rotatable angled connectors

Presentation

BMH servo motors provide unequalled power density values to meet the requirements of most compact machines. With four flange sizes and three different lengths for each flange size, they are suitable for most applications, covering a continuous stall range from 1.2 to 84 Nm for a maximum speed of 8000 rpm.

With their medium inertia motor, the new BMH servo motors are ideal for high-load applications and enable more robust adjustment of the movement, making for easier installation and adjustment.

They are certified as "Recognized"  by the Underwriters Laboratories and conform to UL 1004 standards as well as to European directives (CE marking).

They are available with the following variants:

- 4 flange sizes: 70, 100, 140 and 205 mm
- 2 degrees of protection for the shaft end: IP 50 or IP 65 (IP 67 with the conformity kit, which is available as an option) in accordance with standard IEC/EN 60529. The degree of protection of the casing is IP 65 (IP 67 with the conformity kit, which is available as an option)
- With or without holding brake
- Straight or angled connectors for power and encoder connection
- Integrated SinCos Hiperface® single turn or multiturn encoder (medium or high resolution)
- Untapped or keyed shaft end

Special features

BMH servo motors have been developed to comply with the following main specifications:

- The ambient operating temperature is - 20...+ 40°C without derating, in accordance with standard DIN 50019R14, and up to 55°C with derating of 1% of the nominal output power per additional °C above 40°C.
- The maximum operating altitude is 1000 m without derating, 2000 m with $k = 0.86$ and 3000 m with $k = 0.8$ (1).
The relative humidity that the servo motor can withstand is in line with standard IEC 60721-3-3, category 3K4.
- The windings are insulation class F (maximum temperature for windings 155°C) in accordance with standard DIN VDE 0530.
- Thermal protection provided and controlled by the Lexium 32 servo drive via the motor temperature control algorithm.
- All mounting positions are permitted (horizontal mounting (IMB5) or vertical mounting (IMV1 with shaft end at the top and IMV3 with shaft end at the bottom) in accordance with standard DIN 42950.

Sizing

The Lexium Sizer sizing tool is available on our website www.schneider-electric.com to help you size your servo motor.

(1) *k*: derating factor

Presentation (continued)

Holding brake

BMH servo motors can be equipped with a failsafe electromagnetic holding brake.

⚠ Do not use the holding brake as a dynamic brake for deceleration, as this will quickly damage the brake.

Integrated encoder

BMH servo motors are equipped as standard with an absolute encoder.

This encoder performs the following functions:

- Gives the absolute position of the motor so that flows can be synchronized
- Measures the servo motor speed via the associated Lexium 32 servo drive. This information is used by the servo drive's speed controller
- Measures the position information for the servo drive's position controller
- Sends data from the servo motor to the servo drive, which ensures automatic identification of the motor when the servo drive starts

Four types of encoder are available:

- High resolution SinCos Hiperface® encoder:
 - Single turn (131,072 points/turn) (1) or
 - Multiturn (131,072 points/turn x 4096 turns) (1),
ensuring angular precision of the shaft position, accurate to less than ± 1.3 arc minutes
- Medium resolution SinCos Hiperface® encoder:
 - Single turn (32,768 points/turn) (1) or
 - Multiturn (32,768 points/turn x 4096 turns) (1),
ensuring angular precision of the shaft position, accurate to less than ± 4.8 arc minutes.

Description

BMH servo motors, with a three-phase stator and a 10-pole rotor with Neodymium Iron Boron (NdFeB) magnets, consist of:

- 1 A casing protected by opaque RAL 9005 black paint
- 2 A 4-point axial fixing flange
- 3 A keyed or untapped shaft end (depending on the model)
- 4 A threaded dust and damp proof male straight connector for connecting the power cable (2)
- 5 A threaded dust and damp proof male straight connector for connecting the control cable (encoder) (2)

Connectors to be ordered separately, for connection to Lexium 32 servo drives (see page 62102/4).

Schneider Electric has taken particular care to ensure compatibility between BMH servo motors and Lexium 32 servo drives.

This compatibility can only be assured by using cables and connectors sold by Schneider Electric (see page 62102/4).

(1) Encoder resolution given for use with a Lexium 32 servo drive.

(2) Other model with rotatable angled connector (see page 62102/3).

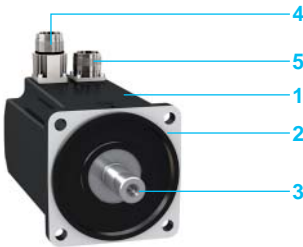



BMH servo motors

The BMH servo motors shown below are supplied without a gearbox. For GBX and GBY gearboxes, see pages 62106/5 and 62106/6.

Continuous stall torque	Peak stall torque	Nominal servo motor output power	Nominal speed	Maximum mechanical speed	Associated LXM 32 servo drive	Reference (1)	Weight (2)
Nm	Nm	W	rpm	rpm			kg
1.2	4.2	350	3000	8000	●U60N4	BMH 0701P ●●●●A	1.600
1.4	4	450	4000	8000	●U90M2	BMH 0701T ●●●●A	1.600
	4.2	350	2500	8000	●D18M2	BMH 0701T ●●●●A	1.600
2.5	6.4	700	5000	8000	●D12N4	BMH 0701P ●●●●A	1.600
		900	4000	8000	●D18M2		
		700	3000	8000	●D12N4	BMH 0702P ●●●●A	1.800
3.4	8.7	650	2000	8000	●D30M2	BMH 0703T ●●●●A	2.000
		900	3000	8000	●D18M2	BMH 0703T ●●●●A	2.000
		1300	5000	8000	●D18N4	BMH 0703P ●●●●A	2.000
3.3	10.8	800	4000	6000	●D12N4	BMH 1001P ●●●●A	3.340
3.4	8.9	700	2000	6000	●D30M2	BMH 1001T ●●●●A	3.340
		900	3000	6000	●D18M2		
		1300	4000	6000	●D18N4	BMH 1001P ●●●●A	3.340
6	10.3	750	2000	6000	●D30M2	BMH 1002T ●●●●A	4.920
		1450	3000	6000	●D30M2		
5.9	18.4	1600	4000	6000	●D18N4	BMH 1002P ●●●●A	4.920
8	23.5	1450	2500	5000	●D30M2	BMH 1003T ●●●●A	6.500
8.4	25.1	2600	4000	5000	●D30N4	BMH 1003P ●●●●A	6.500
10.3	30.8	1450	1500	4000	●D30M2	BMH 1401P ●●●●A	8.000
		2400	3000	4000	●D30N4		
16.8	50.3	3800	3000	4000	●D72N4	BMH 1402P ●●●●A	12.000
24	71.8	4500	3000	4000	●D72N4	BMH 1403P ●●●●A	16.000
34.4	103.4	5400	2000	3800	●D72N4	BMH 2051P ●●●●A	33.000
62.5	170	6500	1500	3800	●D72N4	BMH 2052P ●●●●A	44.000
84	232	6500	1200	3800	●D72N4	BMH 2053P ●●●●A	67.000

To order a BMH servo motor, complete each reference above with:

		BMH 0701P				A
Shaft end	IP 54	Untapped	0			
		Keyed	1			
	IP 65/IP 67 (3)	Untapped	2			
		Keyed	3			
Integrated sensor High resolution, optical	Single turn, SinCos Hiperface® 131,072 points/turn (4) 128 sine/cosine periods per turn		1			
	Multiturn, SinCos Hiperface® 131,072 points/turn x 4096 turns (4) 128 sine/cosine periods per turn		2			
Integrated sensor Medium resolution, capacitive	Single turn, SinCos Hiperface® 32,768 points/turn (4) 16 sine/cosine periods per turn		6			
	Multiturn, SinCos Hiperface® 32,768 points/turn x 4096 turns (4) 16 sine/cosine periods per turn		7			
Holding brake	Without			A		
	With			F		
Connections	Straight connectors				1	
	Rotatable right-angled connectors				2	
Flange	International standard				A	

Note: The example above is for a BMH 0701P servo motor. For other servo motors, replace BMH 0701P with the relevant reference.

(1) To complete each reference see the table above.

(2) Weight of servo motor without brake, no packaging. To obtain the weight of the servo motor with holding brake, please consult our website www.schneider-electric.com.

(3) IP 67 with the VW3 M2 30● IP 67 conformity kit supplied as an option (see opposite page).

(4) Sensor resolution given for use with a Lexium 32 servo drive.

BMH servo motors (continued)			
Dimensions (overall)			
Servo motors	Flange	W x H x D (1)	
		Without holding brake	With holding brake
		mm	mm
BMH 0701●	70 x 70	70 x 109.5 x 122	70 x 109.5 x 161
BMH 0702●	70 x 70	70 x 109.5 x 154	70 x 109.5 x 193
BMH 0703●	70 x 70	70 x 109.5 x 186	70 x 109.5 x 225
BMH 1001●	100 x 100	100 x 139.5 x 128	100 x 139.5 x 170
BMH 1002●	100 x 100	100 x 139.5 x 160	100 x 139.5 x 202
BMH 1003●	100 x 100	100 x 139.5 x 192	100 x 139.5 x 234
BMH 1401P	140 x 140	140 x 179.5 x 152	140 x 179.5 x 187
BMH 1402P	140 x 140	140 x 179.5 x 192	140 x 179.5 x 227
BMH 1403P	140 x 140	140 x 179.5 x 232	140 x 179.5 x 267
BMH 2051P	205 x 205	205 x 259 (2) x 321	205 x 259 (2) x 370.5
BMH 2052P	205 x 205	205 x 259 (2) x 405	205 x 259 (2) x 454.5
BMH 2053P	205 x 205	205 x 259 (2) x 489	205 x 259 (2) x 538.5

IP 67 conformity kits

This kit can be used to provide IP 67 degree of protection. It is fitted in place of the rear motor rating plate.

Description	For use with	Reference	Weight kg
IP 67 conformity kits (supplied as an option)	BMH 070●●	VW3 M2 301	0.100
	BMH 100●●	VW3 M2 302	0.150
	BMH 140●●	VW3 M2 303	0.300
	BMH 205●●	VW3 M2 304	0.750

(1) D: dimensions of the casing (excluding shaft end).

(2) Height of the servo motor equipped with straight connectors. The height is 265 mm when the servo motor is equipped with rotatable angled connectors.

PFM09322



VW3 M2 301●

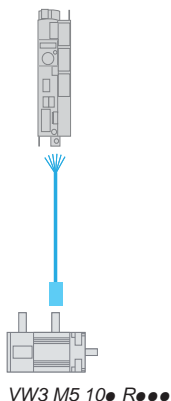

Connection elements

Power cordsets

Description	From servo motor	To servo drive	Composition	Length	Reference	Weight
				m		kg
Cordsets equipped with one M23 industrial connector (servo motor end)	BMH 070●● BMH 100●● BMH 1401P	LXM 32●●●●●●, see combinations on our website www.schneider-electric.com	[(4 x 1.5 mm ²) + (2 x 1 mm ²)]	1.5	VW3 M5 101 R15	0.600
				3	VW3 M5 101 R30	0.810
				5	VW3 M5 101 R50	1.210
				10	VW3 M5 101 R100	2.290
				15	VW3 M5 101 R150	3.400
				20	VW3 M5 101 R200	4.510
				25	VW3 M5 101 R250	6.200
				50	VW3 M5 101 R500	12.325
				75	VW3 M5 101 R750	18.450
				Cordsets equipped with one M40 industrial connector (servo motor end)	BMH 1402P BMH 1403P	LXM 32●D72N4
5	VW3 M5 102 R50	1.670				
10	VW3 M5 102 R100	3.210				
15	VW3 M5 102 R150	4.760				
20	VW3 M5 102 R200	6.300				
25	VW3 M5 102 R250	7.945				
50	VW3 M5 102 R500	16.170				
75	VW3 M5 102 R750	24.095				
Cordsets equipped with one M40 industrial connector (servo motor end)	BMH 205●P	LXM 32●D72N4	[(4 x 4 mm ²) + (2 x 1 mm ²)]	3	VW3 M5 103 R30	1.330
				5	VW3 M5 103 R50	2.130
				10	VW3 M5 103 R100	4.130
				15	VW3 M5 103 R150	6.120
				20	VW3 M5 103 R200	8.090
				25	VW3 M5 103 R250	11.625
				50	VW3 M5 103 R500	23.175
75	VW3 M5 103 R750	34.725				

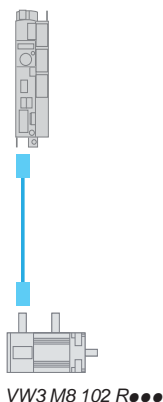

Control cordsets

Description	From servo motor	To servo drive	Composition	Length	Reference	Weight
				m		kg
SinCos Hiperface® encoder cordsets equipped with an M23 industrial connector (servo motor end) and an RJ45 connector with 8 + 2 contacts (servo drive end)	BMH ●●●●●	LXM 32●●●●●●, see combinations on our website www.schneider-electric.com	[3 x (2 x 0.14 mm ²) + (2 x 0.34 mm ²)]	1.5	VW3 M8 102 R15	0.400
				3	VW3 M8 102 R30	0.500
				5	VW3 M8 102 R50	0.600
				10	VW3 M8 102 R100	0.900
				15	VW3 M8 102 R150	1.100
				20	VW3 M8 102 R200	1.400
				25	VW3 M8 102 R250	1.700
				50	VW3 M8 102 R500	3.100
75	VW3 M8 102 R750	4.500				

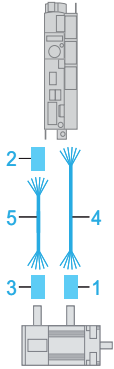
**Connection elements (continued)****Connectors for creating power and control cordsets**

Description	For use with	Item no.	For cable cross-section	Reference	Weight
					mm ²
M23 industrial connector for creating power cordsets (sold in multiples of 5)	BMH 070●●, BMH 100●● and BMH 140●P servo motors	1	1.5 or 2.5	VW3 M8 215	0.350
M40 industrial connector for creating power cordsets (sold in multiples of 5)	BMH 205●P servo motors	1	4	VW3 M8 217	0.850
RJ45 connector with 8 + 2 contacts for creating control cordsets (sold in multiples of 5)	LXM 32●●●●● servo drives (CN3 connector)	2	–	VW3 M2 208	0.200
M23 industrial connector for creating control cordsets (sold in multiples of 5)	BMH ●●●●● servo motors	3	–	VW3 M8 214	0.350

Cables for creating power and control cordsets

Description	From servo motor	To servo drive	Composition	Item no.	Length	Reference	Weight
					m		kg
Cables for creating power cordsets	BMH 070●●, BMH 100●●, BMH 1401P	LXM 32●●●●●, see combinations on our website www.schneider-electric.com	[(4 x 1.5 mm ²) + (2 x 1 mm ²)]	4	25	VW3 M5 301 R250	5.550
					50	VW3 M5 301 R500	11.100
					100	VW3 M5 301 R1000	22.200
	BMH 1402P, BMH 1403P	LXM 32●D72N4	[(4 x 2.5 mm ²) + (2 x 1 mm ²)]	4	25	VW3 M5 302 R250	7.725
					50	VW3 M5 302 R500	15.450
					100	VW3 M5 302 R1000	30.900
	BMH 205●P	LXM 32●D72N4	[(4 x 4 mm ²) + (2 x 1 mm ²)]	4	25	VW3 M5 303 R250	9.900
					50	VW3 M5 303 R500	19.800
					100	VW3 M5 303 R1000	39.600
Cables for creating control cordsets for SinCos Hiperface® encoders	BMH ●●●●●	LXM 32●●●●●, see combinations on our website www.schneider-electric.com	[(3 x (2 x 0.14 mm ²) + (2 x 0.34 mm ²))]	5	25	VW3 M8 222 R250	1.400
					50	VW3 M8 222 R500	2.800
					100	VW3 M8 222 R1000	5.600

Holding brake

Presentation

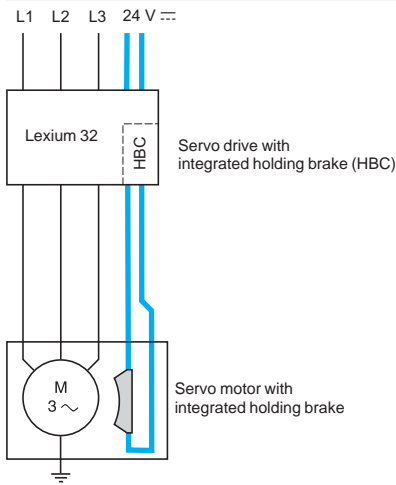

The holding brake integrated in the BMH servo motor is an electromagnetic pressure spring brake that blocks the servo motor axis once the output current has been switched off.

In the event of an emergency, such as a power outage or an emergency stop, the drive is immobilized, significantly increasing safety. Blocking the servo motor axis is also necessary in cases of torque overload, such as in the event of vertical axis movement.

As standard, the Lexium 32 servo drive has a holding brake controller which amplifies the braking control signal, ensuring the brake is deactivated quickly. The controller then reduces the control signal so as to decrease the power dissipated by the holding brake.

References



BMH servo motor

Selection of BMH servo motor with or without holding brake, see references on page 62102/3.

For any additional information about the holding brake characteristics, visit our website www.schneider-electric.com.

Encoder integrated in BMH servo motor

Presentation

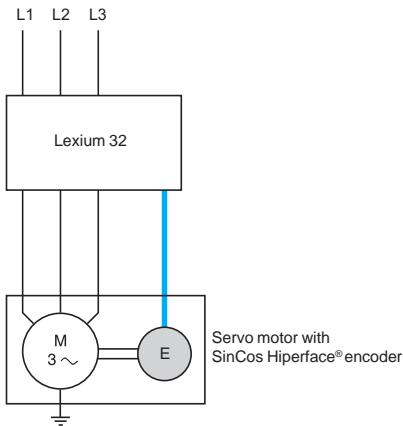

The standard measurement device is the SinCos Hiperface® single turn or multiturn encoder integrated in BMH servo motors. This measurement device is perfectly adapted to the Lexium 32 range of servo drives.

Depending on the model, single turn and multiturn SinCos encoders are available in medium resolution, with capacitive sensing, or high resolution, with optical sensing.

Use of this interface enables:

- Automatic identification of BMH servo motor data by the servo drive
- Automatic initialization of the servo drive's control loops, thus simplifying installation of the motion control device

References



BMH servo motor

Selection of type of SinCos Hiperface® encoder integrated into the BMH servo motor (single turn or multiturn), see references on page 62102/3.

For any additional information about the integrated encoder characteristics, visit our website www.schneider-electric.com.

PF080936



GBX planetary gearbox

PF080937



GBY angular planetary gearbox

PF080938

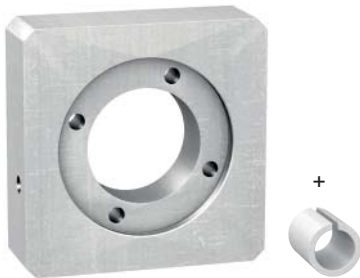

GBK adaptation kit

Presentation

In many cases, motion control requires the use of planetary gearboxes to adapt speeds and torques, while ensuring the precision demanded by the application.

Schneider Electric has chosen to use GBX planetary gearboxes and GBY angular planetary gearboxes (made by Neugart) with the BMH range of servo motors. The combination of BMH servo motors with the most suitable planetary gearboxes makes them very easy to mount and ensures simple, risk-free operation.

The gearboxes are designed for applications which are not susceptible to mechanical backlash. They have a keyed shaft, are lubricated for life and conform to IP 54 degree of protection.

Available in 4 sizes (GBX 60...GBX 160), GBX planetary gearboxes are offered in 15 gear ratios (3:1...100:1).

GBY angular planetary gearboxes are available in 3 sizes (GBY 60...GBY 120), in 7 gear ratios (3:1...40:1).

The tables on pages 62106/5 and 62106/6 show the most suitable combinations of servo motor and GBX or GBY planetary gearbox.

For other combinations or any additional information about the characteristics of planetary gearboxes, see the servo motor data sheets or visit our website www.schneider-electric.com.

A GBK adaptation kit is also offered for assembling the BMH servo motor and the GB● planetary gearbox, see page 62106/7.

It comprises:

- An adaptor plate
- A shaft end adaptor, depending on the model (depends on the servo motor/planetary gearbox combination)
- Screws and bolts for mounting the plate on the planetary gearbox
- Screws and bolts for mounting the servo motor

References

PF000936



GBX ●●●●● K planetary gearbox

Size	Gear ratio	Reference	Weight kg
GBX 60	3:1, 4:1, 5:1 and 8:1	GBX 060●●● K	0.900
	9:1, 12:1, 15:1, 16:1	GBX 060●●● K	1.000
GBX 80	3:1, 4:1, 5:1 and 8:1	GBX 080●●● K	2.100
	9:1, 12:1, 15:1, 16:1, 20:1, 25:1, 32:1 and 40:1	GBX 080●●● K	2.600
GBX 120	3:1, 4:1, 5:1 and 8:1	GBX 120●●● K	6.000
	9:1, 12:1, 15:1, 16:1, 20:1, 25:1, 32:1 and 40:1	GBX 120●●● K	8.000
	60:1, 80:1 and 100:1	GBX 120●●● K	10.000
GBX 160	8:1	GBX 160●●● K	18.000
	12:1, 15:1, 16:1, 20:1, 25:1, 32:1 and 40:1	GBX 160●●● K	22.000

To order a GBX planetary gearbox, complete each reference above as follows:

Size	Casing diameter	GBX	●●●	●●●	K
Size	60 mm		060		
	80 mm		080		
	120 mm		120		
	160 mm (▲)		160		
Gear ratio	3:1			003	
	4:1			004	
	5:1			005	
	8:1			008	
	9:1			009	
	12:1			012	
	15:1			015	
	16:1			016	
	20:1			020	
	25:1			025	
	32:1			032	
	40:1			040	
	60:1			060	
80:1			080		
100:1			100		
Mounting with GBK adaptation kit (see page 62106/7)					K

BMH servo motor/GBX planetary gearbox combinations

Gear ratios from 3:1 to 100:1

Type of servo motor	Gear ratio											
	3:1 4:1	5:1	8:1	9:1	12:1	15:1 16:1	20:1	25:1	32:1	40:1	60:1 80:1	100:1
BMH 0701	GBX 060	GBX 060	GBX 060	GBX 060	GBX 060	GBX 060	GBX 080	GBX 080	GBX 080	GBX 080	GBX 120	GBX 120
BMH 0702	GBX 060	GBX 060	GBX 080	GBX 060	GBX 060	GBX 080	GBX 080	GBX 080	GBX 120	GBX 120	GBX 120	GBX 120
BMH 0703	GBX 060	GBX 060	GBX 080	GBX 060	GBX 080	GBX 080	GBX 080	GBX 120	GBX 120	GBX 120	GBX 120	GBX 120
BMH 1001	GBX 080	GBX 080	GBX 080	GBX 080	GBX 080	GBX 080	GBX 080	GBX 120	GBX 120	GBX 120	–	–
BMH 1002	GBX 080	GBX 080	GBX 120	GBX 080	GBX 080	GBX 120	GBX 120	GBX 160	GBX 160	GBX 160	–	–
BMH 1003	GBX 080	GBX 080	GBX 120	GBX 080	GBX 120	GBX 120	GBX 120	GBX 160	GBX 160	GBX 160	–	–
BMH 1401	GBX 120	GBX 120	GBX 120	GBX 120	GBX 120	GBX 160	GBX 160	GBX 160	GBX 160	GBX 160	–	–
BMH 1402	GBX 120	GBX 120	GBX 160	–	GBX 160	GBX 160	GBX 160	GBX 160	GBX 160	GBX 160	–	–
BMH 1403	GBX 120	GBX 120	GBX 160	–	GBX 160	GBX 160	GBX 160	GBX 160	GBX 160	GBX 160	–	–

GBX 060

For these combinations, you must check that the application will not exceed the maximum gearbox output torque, see the values on our website www.schneider-electric.com.

▲ Available 2nd quarter 2011

Lexium 32 motion control

BMH servo motors

Option: GBY angular planetary gearboxes

PF060937



GBY ●●●●● K angular planetary gearbox

Size	Gear ratio	Reference	Weight kg
GBY 60	3:1, 4:1, 5:1 and 8:1	GBY 060●●● K	1.700
	12:1	GBY 060●●● K	1.900
GBY 80	3:1, 4:1, 5:1 and 8:1	GBY 080●●● K	4.400
	12:1, 20:1 and 40:1	GBY 080●●● K	5.000
GBY 120	3:1, 4:1, 5:1 and 8:1	GBY 120●●● K	12.000
	12:1, 20:1 and 40:1	GBY 120●●● K	14.000

To order a GBY angular planetary gearbox, complete each reference above as follows:

Size	Casing diameter	GBY	●●●	●●●	K
	60 mm		060		
	80 mm		080		
	120 mm		120		
Gear ratio	3:1			003	
	4:1			004	
	5:1			005	
	8:1			008	
	12:1			012	
	20:1			020	
	40:1			040	
Mounting with GBK adaptation kit (see page 62106/7)					K

BMH servo motor/GBY angular planetary gearbox combinations

Gear ratios from 3:1 to 40:1

Type of servo motor	Gear ratio						
	3:1	4:1	5:1	8:1	12:1	20:1	40:1
BMH 0701	GBY 060	GBY 060	GBY 060	GBY 060	GBY 060	GBY 080	GBY 080
BMH 0702	GBY 060	GBY 060	GBY 060	GBY 080	GBY 080	GBY 080	GBY 120
BMH 0703	GBY 080	GBY 080	GBY 080	GBY 080	GBY 080	GBY 080	GBY 120
BMH 1001	GBY 080	GBY 080	GBY 080	GBY 080	GBY 080	GBY 080	GBY 120
BMH 1002	GBY 080	GBY 080	GBY 080	GBY 120	GBY 080	GBY 120	-
BMH 1003	GBY 120	GBY 120	GBY 120	GBY 120	GBY 120	GBY 120	-
BMH 1401	GBY 120	GBY 120	GBY 120	GBY 120	GBY 120	-	-

GBY 060

For these combinations, you must check that the application will not exceed the maximum gearbox output torque, see the values on our website www.schneider-electric.com.

References		To order a GBK adaptation kit (1), complete each reference as follows:				
		GBK	●●●	●●●	●	F
Size of GBX or GBY planetary gearbox	Casing diameter	60 mm	060			
		80 mm	080			
		120 mm	120			
		160 mm	160			
Associated servo motor		BMH 070		070		
		BMH 100		100		
		BMH 140		140		
Compatibility	Motor with any type of stack				0	
	Motor with 1 or 2 stacks				2	
	Motor with 1, 2 or 3 stacks				3	
BMH servo motor adaptation						F

GBK adaptation kit/BMH servo motor combination									
Type of gearbox	BMH servo motor								
	0701 ●	0702 ●	0703 ●	1001 ●	1002 ●	1003 ●	1401 ●	1402 ●	1403 ●
GBK 060 070 2 F	Compatible	Compatible	Incompatible	Incompatible	Incompatible	Incompatible	Incompatible	Incompatible	Incompatible
GBK 060 070 3F	Compatible	Compatible	Incompatible	Incompatible	Incompatible	Incompatible	Incompatible	Incompatible	Incompatible
GBK 080 070 2F	Compatible	Compatible	Incompatible	Incompatible	Incompatible	Incompatible	Incompatible	Incompatible	Incompatible
GBK 080 070 3F	Compatible	Compatible	Incompatible	Incompatible	Incompatible	Incompatible	Incompatible	Incompatible	Incompatible
GBK 080 100 3F	Incompatible	Incompatible	Incompatible	Compatible	Compatible	Compatible	Incompatible	Incompatible	Incompatible
GBK 120 070 2F	Compatible	Compatible	Incompatible	Incompatible	Incompatible	Incompatible	Incompatible	Incompatible	Incompatible
GBK 120 070 3F	Compatible	Compatible	Incompatible	Incompatible	Incompatible	Incompatible	Incompatible	Incompatible	Incompatible
GBK 120 100 3F	Incompatible	Incompatible	Incompatible	Compatible	Compatible	Compatible	Incompatible	Incompatible	Incompatible
GBK 120 140 0F	Incompatible	Incompatible	Incompatible	Incompatible	Incompatible	Incompatible	Compatible	Compatible	Compatible
GBK 160 100 3F	Incompatible	Incompatible	Incompatible	Compatible	Compatible	Compatible	Incompatible	Incompatible	Incompatible
GBK 160 140 0F	Incompatible	Incompatible	Incompatible	Incompatible	Incompatible	Incompatible	Compatible	Compatible	Compatible

 Compatible
 Incompatible

(1) Weight of adaptation kit:
 ■ GBK 060●●●F: 0.200 kg
 ■ GBK 080●●●F: 0.450 kg
 ■ GBK 120●●●F: 0.650 kg
 ■ GBK 160●●●F: 0.900 kg

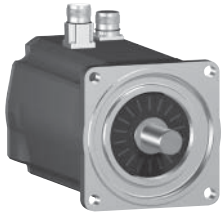

BSH servo motor with straight connectors



BSH servo motor with rotatable angled connectors

Presentation

BSH servo motors are the ideal choice to meet requirements for dynamics and precision. With five flange sizes and a variety of lengths, there is a suitable solution for most applications, covering a continuous stall torque range from 0.5 to 33.4 Nm for a maximum speed of 9000 rpm.

Thanks to their new winding technology based on salient poles, BSH servo motors are far more compact and offer a higher power density than conventional servo motors.

BSH servo motors are certified as “Recognized”  by the Underwriters Laboratories and conform to UL 1004 standards as well as to European directives (CE marking).

They are available with the following variants:

- 4 flange sizes: 55, 70, 100 and 140 mm
- 2 degrees of protection for the shaft end: IP 50 or IP 65 in accordance with standard IEC/EN 60529. The degree of protection of the casing is IP 65 (IP 67 with the conformity kit, which is available as an option)
- With or without holding brake
- Straight or angled connectors for power and encoder connection
- Integrated SinCos Hiperface® single turn or multiturn encoder (medium or high resolution)
- Untapped or keyed shaft end

Special features

BSH servo motors have been developed to comply with the following main specifications:

- The ambient operating temperature is - 20...+ 40°C without derating, in accordance with standard DIN 50019R14, and up to 55°C with derating of 1% of the nominal output power per additional °C above 40°C.
- The maximum operating altitude is 1000 m without derating, 2000 m with $k = 0.86$ and 3000 m with $k = 0.8$ (1).
The relative humidity that the servo motor can withstand is in line with standard IEC 60721-3-3, category 3K4.
- The windings are insulation class F (maximum temperature for windings 155°C) in accordance with standard DIN VDE 0530.
- All mounting positions are permitted (horizontal mounting (IMB5) or vertical mounting (IMV1 with shaft end at the top and IMV3 with shaft end at the bottom) in accordance with standard DIN 42950.

Sizing

The Lexium Sizer sizing tool is available on our website www.schneider-electric.com to help you size your servo motor.

(1) *k*: derating factor

Presentation (continued)

Holding brake

BSH servo motors can be equipped with a failsafe electromagnetic holding brake.

⚠ Do not use the holding brake as a dynamic brake for deceleration, as this will quickly damage the brake.

Integrated encoder

BSH servo motors are equipped with a SinCos Hiperface® high-resolution single turn (131,072 points/turn) (1) or multturn (131,072 points/turn x 4096 turns) (1) encoder providing angular precision of the shaft position, accurate to less than ± 1.3 arc minutes.

This encoder performs the following functions:

- Gives the absolute position of the motor so that flows can be synchronized.
- Measures the servo motor speed via the associated Lexium 32 servo drive. This information is used by the servo drive's speed controller.
- Measures the position information for the servo drive's position controller.
- Sends data from the servo motor to the servo drive, which ensures automatic identification of the motor when the servo drive starts.

Description

BSH servo motors, with a 3-phase stator and a 6 to 10-pole rotor (depending on model) with Neodymium Iron Borium (NdFeB) magnets, consist of:

- 1 A casing protected by opaque RAL 9005 black paint
- 2 A 4-point axial fixing flange
- 3 A keyed or untapped shaft end (depending on the model)
- 4 A threaded dust and damp proof male straight connector for connecting the power cable (2)
- 5 A threaded dust and damp proof male straight connector for connecting the control cable (encoder) (2)

Connectors to be ordered separately, for connection to Lexium 32 servo drives (see page 62112/4).

Schneider Electric has taken particular care to ensure compatibility between BSH servo motors and Lexium 32 servo drives. This compatibility can only be assured by using cables and connectors sold by Schneider Electric (see page 62112/4).

(1) Encoder resolution given for use with a Lexium 32 servo drive.

(2) Other model with rotatable angled connector (see page 62112/3).

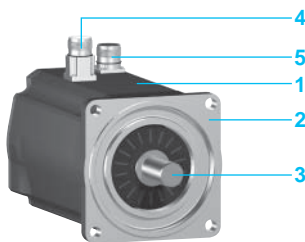

105980



BSH 055●●●●●1A

105981



BSH 070●●●●●1A

105982



BSH 100●●●●●1A

105983

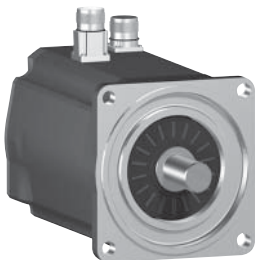

BSH 1401P●●●●●1A

BSH servo motors

The BSH servo motors shown below are supplied without a gearbox.
For GBX and GBY gearboxes, see pages 62116/5 and 62116/6.

Continuous stall torque	Peak stall torque	Nominal servo motor output power	Nominal speed	Maximum mechanical speed	Associated LXM 32 servo drive	Reference (1)	Weight (2)
Nm	Nm	W	rpm	rpm			kg
0.5	1.4	300	6000	9000	●U45M2	BSH 0551T ●●●●●A	1.160
		150	3000	9000	●U90M2	BSH 0551T ●●●●●A	1.160
	300	6000	9000	●U60N4	BSH 0551P ●●●●●A	1.160	
0.8	1.9	250	3000	9000	●U90M2	BSH 0552T ●●●●●A	1.470
		450	6000	9000	●U90M2	BSH 0552T ●●●●●A	1.470
	400	6000	9000	●U60N4	BSH 0552P ●●●●●A	1.470	
1.05	3.5	400	6000	9000	●U60N4	BSH 0553P ●●●●●A	1.760
		550	6000	9000	●U90M2	BSH 0553T ●●●●●A	1.760
1.2	3	350	3000	9000	●D18M2		
		500	5000	8000	●U90M2	BSH 0701T ●●●●●A	2.200
1.3	3.5	350	2500	8000	●D18M2	BSH 0701T ●●●●●A	2.200
		700	5000	8000	●D12N4	BSH 0701P ●●●●●A	2.200
2.2	6.1	550	2500	8000	●D30M2	BSH 0702T ●●●●●A	2.890
		950	5000	8000	●D18M2		
	850	5000	8000	●D12N4	BSH 0702P ●●●●●A	2.890	
2.6	7.4	900	4000	8000	●D18M2	BSH 0703T ●●●●●A	3.620
		900	4000	6000	●D18M2	BSH 1001T ●●●●●A	4.200
3.1	11.3	1300	5000	8000	●D18N4	BSH 0703P ●●●●●A	3.620
		700	2500	6000	●D30M2	BSH 1001T ●●●●●A	4.200
3.3	6.3	1100	4000	6000	●D18N4	BSH 1001P ●●●●●A	4.200
		1500	4000	6000	●D30M2	BSH 1002T ●●●●●A	5.900
5.8	16.4	1700	4000	6000	●D18N4	BSH 1002P ●●●●●A	5.900
		2000	3000	6000	●D30N4	BSH 1003P ●●●●●A	7.400
8	28.3	2600	4000	6000	●D30N4	BSH 1003P ●●●●●A	7.400
		2100	2500	6000	●D30N4	BSH 1004P ●●●●●A	9.500
10	37.9	2600	3000	6000	●D30N4	BSH 1004P ●●●●●A	9.500
		2500	2500	4000	●D30N4	BSH 1401P ●●●●●A	11.200
11.1	27	3000	3000	4000	●D30N4	BSH 1401P ●●●●●A	11.200
		3900	3000	4000	●D72N4	BSH 1402T ●●●●●P	16.000
19.5	59.3	4100	3000	4000	●D72N4	BSH 1403T ●●●●●P	21.200
		5000	2500	4000	●D72N4	BSH 1404P ●●●●●P	26.500
27.8	90.2	4100	3000	4000	●D72N4	BSH 1403T ●●●●●P	21.200
33.4	103.6	5000	2500	4000	●D72N4	BSH 1404P ●●●●●P	26.500

(1) To complete each reference see the table on page 62112/3.

(2) Weight of servo motor without brake, no packaging. To obtain the weight of the servo motor with holding brake, please consult our website www.schneider-electric.com.

BSH servo motors (continued)						
To order a BSH servo motor, complete each reference on the opposite page with:						
			BSH 0551T	•	•	•
Shaft end	IP 50	Untapped	0			
		Keyed	1			
	IP 65/IP 67 (1)	Untapped	2			
		Keyed	3			
Integrated sensor High resolution, optical	Single turn, SinCos Hiperface® 131,072 points/turn (2)			1		
	Multiturn, SinCos Hiperface® 131,072 points/turn x 4096 turns (2)			2		
Holding brake	Without				A	
	With				F	
Connections	Straight connectors					1
	Rotatable right-angled connectors					2
Flange	International standard					A or P (3)

Note: The example above is for a **BSH 0551T** servo motor. For other servo motors, replace **BSH 0551T** with the relevant reference.

Dimensions (overall)			
Servo motors	Flange	W x H x D (4)	
		Without holding brake	With holding brake
		mm	mm
BSH 0551●	55 x 55	55 x 94.5 x 132.5	55 x 94.5 x 159
BSH 0552●	55 x 55	55 x 94.5 x 154.5	55 x 94.5 x 181
BSH 0553●	55 x 55	55 x 94.5 x 176.5	55 x 94.5 x 203
BSH 0701●	70 x 70	70 x 111.5 x 154	70 x 111.5 x 180
BSH 0702●	70 x 70	70 x 111.5 x 187	70 x 111.5 x 213
BSH 0703●	70 x 70	70 x 111.5 x 220	70 x 111.5 x 254
BSH 1001●	100 x 100	100 x 138.5 x 169	100 x 138.5 x 200
BSH 1002●	100 x 100	100 x 138.5 x 205	100 x 138.5 x 236
BSH 1003●	100 x 100	100 x 138.5 x 241	100 x 138.5 x 272
BSH 1004●	100 x 100	100 x 138.5 x 277	100 x 138.5 x 308
BSH 1401P	140 x 140	140 x 178 x 218	140 x 178 x 256
BSH 1402T	140 x 140	140 x 192.5 (5) x 273	140 x 192.5 (5) x 311
BSH 1403T	140 x 140	140 x 192.5 (5) x 328	140 x 192.5 (5) x 366
BSH 1404P	140 x 140	140 x 192.5 (5) x 383	140 x 192.5 (5) x 421

IP 67 conformity kits

This kit can be used to provide IP 67 degree of protection. It is fitted in place of the rear motor rating plate.

Description	For use with	Reference	Weight kg
IP 67 conformity kits (supplied as an option)	BSH 055●●	VW3 M2 305	0.050
	BSH 070●●	VW3 M2 306	0.100
	BSH 100●●	VW3 M2 307	0.150
	BSH 140●●	VW3 M2 308	0.300

(1) IP 67 with the VW3 M2 30● IP 67 conformity kit supplied as an option (see above).

(2) Sensor resolution given for use with a Lexium 32 servo drive.

(3) "A" or "P" depending on the model (see table of references on page 62112/2).

(4) D = dimensions of the casing (excluding shaft end).

(5) 192.5 mm with straight connector, 198.5 mm with rotatable angled connector.

PF060922



VW3 M2 30●

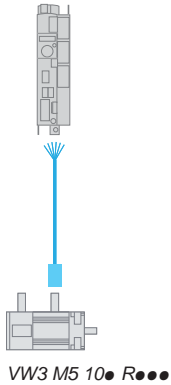

Connection elements						
Power cordsets						
Description	From servo motor	To servo drive	Composition	Length	Reference	Weight
				m		kg
Cordsets equipped with one M23 industrial connector (servo motor end)	BSH 055●● BSH 070●● BSH 100●● BSH 1401P	LXM 32●●●●●●, see combinations on our website www.schneider-electric.com	[(4 x 1.5 mm ²) + (2 x 1 mm ²)]	1.5	VW3 M5 101 R15	0.600
				3	VW3 M5 101 R30	0.810
				5	VW3 M5 101 R50	1.210
				10	VW3 M5 101 R100	2.290
				15	VW3 M5 101 R150	3.400
				20	VW3 M5 101 R200	4.510
				25	VW3 M5 101 R250	6.200
				50	VW3 M5 101 R500	12.325
Cordsets equipped with one M40 industrial connector (servo motor end)	BSH 1402T BSH 1403T BSH 1404P	LXM 32●D72N4	[(4 x 4 mm ²) + (2 x 1 mm ²)]	3	VW3 M5 103 R30	1.330
				5	VW3 M5 103 R50	2.130
				10	VW3 M5 103 R100	4.130
				15	VW3 M5 103 R150	6.120
				20	VW3 M5 103 R200	8.090
				25	VW3 M5 103 R250	11.625
				50	VW3 M5 103 R500	23.175
				75	VW3 M5 103 R750	34.725

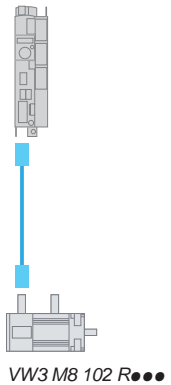

Control cordsets						
Description	From servo motor	To servo drive	Composition	Length	Reference	Weight
				m		kg
SinCos Hiperface® encoder cordsets equipped with an M23 industrial connector (servo motor end) and an RJ45 connector with 8+2 contacts (servo drive end)	BSH ●●●●●	LXM 32●●●●●●, see combinations on our website www.schneider-electric.com	[3 x (2 x 0.14 mm ²) + (2 x 0.34 mm ²)]	1.5	VW3 M8 102 R15	0.400
				3	VW3 M8 102 R30	0.500
				5	VW3 M8 102 R50	0.600
				10	VW3 M8 102 R100	0.900
				15	VW3 M8 102 R150	1.100
				20	VW3 M8 102 R200	1.400
				25	VW3 M8 102 R250	1.700
				50	VW3 M8 102 R500	3.100
75	VW3 M8 102 R750	4.500				

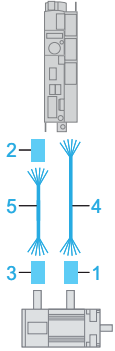
**Connection elements (continued)****Connectors for creating power and control cordsets**

Description	For use with	Item no.	For cable cross-section mm ²	Reference	Weight kg
M23 industrial connector for creating power cordsets (sold in multiples of 5)	BSH 055●●, BSH 070●●, BSH 100●● and BSH 1401P servo motors	1	1.5	VW3 M8 215	0.350
M40 industrial connector for creating power cordsets (sold in multiples of 5)	BSH 1402T, BSH 1403T and BSH 1404P servo motors	1	4	VW3 M8 217	0.850
RJ45 connector with 8+2 contacts for creating control cordsets (sold in multiples of 5)	LXM 32●●●●● servo drives (CN3 connector)	2	–	VW3 M2 208	0.200
M23 industrial connector for creating control cordsets (sold in multiples of 5)	BSH ●●●●● servo motors	3	–	VW3 M8 214	0.350

Cables for creating power and control cordsets

Description	From servo motor	To servo drive	Composition	Item no.	Length m	Reference	Weight kg
Cables for creating power cordsets	BSH 055●●, BSH 070●●, BSH 100●●, BSH 1401P	LXM 32●●●●●, see combinations on our website www.schneider-electric.com	[(4 x 1.5 mm ²) + (2 x 1 mm ²)]	4	25	VW3 M5 301 R250	5.550
					50	VW3 M5 301 R500	11.100
					100	VW3 M5 301 R1000	22.200
Cables for creating control cordsets for SinCos Hiperface® encoders	BSH ●●●●●	LXM 32●D72N4, see combinations on our website www.schneider-electric.com	[(4 x 4 mm ²) + (2 x 1 mm ²)]	4	25	VW3 M5 303 R250	9.900
					50	VW3 M5 303 R500	19.800
					100	VW3 M5 303 R1000	39.600
Cables for creating control cordsets for SinCos Hiperface® encoders	BSH ●●●●●	LXM 32●●●●●, see combinations on our website www.schneider-electric.com	[3 x (2 x 0.14 mm ²) + (2 x 0.34 mm ²)]	5	25	VW3 M8 222 R250	1.400
					50	VW3 M8 222 R500	2.800
					100	VW3 M8 222 R1000	5.600

Holding brake

Presentation

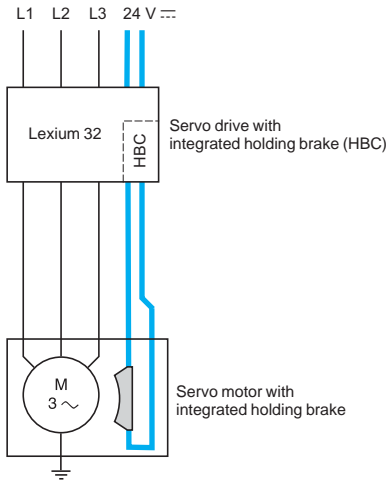

The holding brake integrated in the BSH servo motor is an electromagnetic pressure spring brake that blocks the servo motor axis once the output current has been switched off.

In the event of an emergency, such as a power outage or an emergency stop, the drive is immobilized, significantly increasing safety. Blocking the servo motor axis is also necessary in cases of torque overload, such as in the event of vertical axis movement.

As standard, the Lexium 32 servo drive has a holding brake controller which amplifies the braking control signal, ensuring the brake is deactivated quickly. The controller then reduces the control signal so as to decrease the power dissipated by the holding brake.

References



BSH servo motor

Selection of BSH servo motor with or without holding brake, see references on page 62112/3.

For any additional information about the holding brake characteristics, visit our website www.schneider-electric.com.

Encoder integrated in BSH servo motor

Presentation

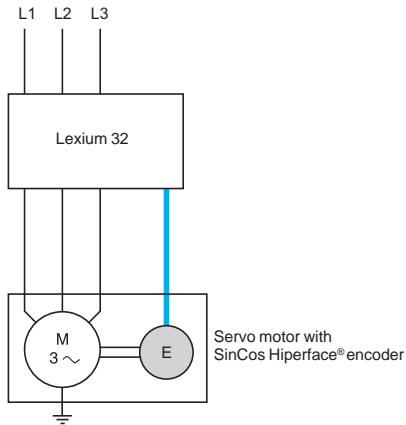

The standard measurement device is the SinCos Hiperface® single turn or multiturn encoder integrated in BSH servo motors. This measurement device is perfectly adapted to the Lexium 32 range of servo drives.

Use of this interface enables:

- Automatic identification of BSH servo motor data by the servo drive
- Automatic initialization of the servo drive's control loops, thus simplifying installation of the motion control device

References



BSH servo motor

Selection of type of SinCos Hiperface® encoder integrated into the BSH servo motor (single turn or multiturn), see references on page 62112/3.

For any additional information about the integrated encoder characteristics, visit our website www.schneider-electric.com.

PF080956



GBX planetary gearbox

PF080937



GBY angular planetary gearbox

PF080938

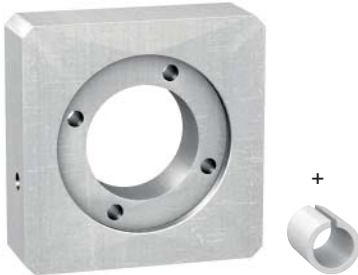

GBK adaptation kit

Presentation

In many cases, motion control requires the use of planetary gearboxes to adapt speeds and torques, while ensuring the precision demanded by the application.

Schneider Electric has chosen to use GBX planetary gearboxes and GBY angular planetary gearboxes (made by Neugart) with the BSH range of servo motors. The combination of BSH servo motors with the most suitable planetary gearboxes makes them very easy to mount and ensures simple, risk-free operation.

The gearboxes are designed for applications which are not susceptible to mechanical backlash. They have a keyed shaft, are lubricated for life and conform to IP 54 degree of protection.

Available in 4 sizes (GBX 60...GBX 160), planetary gearboxes are offered in 15 gear ratios (3:1...100:1). GBY angular planetary gearboxes are available in 3 sizes (GBY 60...GBY 120), in 7 gear ratios (3:1...40:1).

The tables on pages 62116/5 and 62116/6 show the most suitable combinations of servo motor and GBX or GBY planetary gearbox. For other combinations or any additional information about the characteristics of planetary gearboxes, see the servo motor data sheets or visit our website www.schneider-electric.com.

A GBK adaptation kit is also offered for assembling the BMH servo motor and the GB● planetary gearbox, see page 62116/7.

Comprising:

- An adaptor plate
- A shaft end adaptor, depending on the model (depends on the servo motor/planetary gearbox combination)
- Screws for mounting the plate on the planetary gearbox
- Screws for mounting the servo motor

Lexium 32 motion control

BSH servo motors

Option: GBX planetary gearboxes

References

PF090936



GBX ●●●●●● K ● planetary gearbox

Size	Gear ratio	Reference	Weight kg
GBX 60	3:1, 4:1, 5:1 and 8:1	GBX 060●●● K	0.900
	9:1, 12:1, 15:1, 16:1, 20:1, 25:1, 32:1 and 40:1	GBX 060●●● K	1.000
	60:1	GBX 060●●● K	1.300
GBX 80	3:1, 4:1, 5:1 and 8:1	GBX 080●●● K	2.100
	9:1, 12:1, 15:1, 16:1, 20:1, 25:1, 32:1 and 40:1	GBX 080●●● K	2.600
GBX 120	3:1, 4:1, 5:1 and 8:1	GBX 120●●● K	6.000
	9:1, 12:1, 15:1, 16:1, 20:1, 25:1, 32:1 and 40:1	GBX 120●●● K	8.000
	60:1, 80:1 and 100:1	GBX 120●●● K	10.000
GBX 160	8:1	GBX 160●●● K	18.000
	12:1, 15:1, 16:1, 20:1, 25:1, 32:1 and 40:1	GBX 160●●● K	22.000

To order a GBX planetary gearbox, complete each reference above as follows:

Size	Casing diameter	GBX	●●●	●●●	K
Size	60 mm		060		
	80 mm		080		
	120 mm		120		
	160 mm (▲)		160		
Gear ratio	3:1			003	
	4:1			004	
	5:1			005	
	8:1			008	
	9:1			009	
	12:1			012	
	15:1			015	
	16:1			016	
	20:1			020	
	25:1			025	
	32:1			032	
	40:1			040	
	60:1			060	
80:1			080		
100:1			100		
Mounting with GBK adaptation kit (see page 62116/7)					K

BSH servo motor/GBX planetary gearbox combinations

Gear ratios from 3:1 to 100:1

Type of servo motor	Gear ratio												
	3:1 4:1	5:1	8:1	9:1	12:1	15:1 16:1	20:1	25:1	32:1	40:1	60:1	80:1	100:1
BSH 0551	GBX 060	GBX 060	GBX 060	GBX 060	GBX 060	GBX 060	GBX 060	GBX 060	GBX 060	GBX 060	GBX 060	–	–
BSH 0552	GBX 060	GBX 060	GBX 060	GBX 060	GBX 060	GBX 060	GBX 060	GBX 060	GBX 060	–	–	–	–
BSH 0553	GBX 060	GBX 060	GBX 060	GBX 060	GBX 060	GBX 060	GBX 060	–	–	–	–	–	–
BSH 0701	GBX 060	GBX 060	GBX 060	GBX 060	GBX 060	GBX 060	GBX 080	GBX 080	GBX 080	GBX 080	GBX 120	GBX 120	GBX 120
BSH 0702	GBX 060	GBX 060	GBX 080	GBX 060	GBX 060	GBX 080	GBX 080	GBX 080	GBX 120	GBX 120	GBX 120	GBX 120	GBX 120
BSH 0703	GBX 060	GBX 060	GBX 080	GBX 060	GBX 080	GBX 080	GBX 080	GBX 120	GBX 120	GBX 120	GBX 120	GBX 120	GBX 120
BSH 1001	GBX 080	GBX 080	GBX 080	GBX 080	GBX 080	GBX 080	GBX 080	GBX 120	GBX 120	GBX 120	–	–	–
BSH 1002	GBX 080	GBX 080	GBX 120	GBX 080	GBX 080	GBX 120	GBX 120	GBX 160	GBX 160	GBX 160	–	–	–
BSH 1003	GBX 080	GBX 080	GBX 120	GBX 080	GBX 120	GBX 120	GBX 120	GBX 160	GBX 160	GBX 160	–	–	–
BSH 1004	GBX 120	GBX 120	GBX 120	GBX 120	GBX 120	GBX 160	GBX 160	GBX 160	GBX 160	GBX 160	–	–	–
BSH 1401	GBX 120	GBX 120	GBX 120	GBX 120	GBX 120	GBX 160	GBX 160	GBX 160	GBX 160	GBX 160	–	–	–
BSH 1402	GBX 120	GBX 120	GBX 160	–	GBX 160	GBX 160	GBX 160	GBX 160	GBX 160	GBX 160	–	–	–
BSH 1403	GBX 120	GBX 120	GBX 160	–	GBX 160	GBX 160	GBX 160	GBX 160	GBX 160	GBX 160	–	–	–
BSH 1404	GBX 120	GBX 120	GBX 160	–	GBX 160	GBX 160	GBX 160	–	–	–	–	–	–

GBX 060 For these combinations, you must check that the application will not exceed the maximum gearbox output torque, see the values on our website www.schneider-electric.com.

▲ Available 2nd quarter 2011

Servo drives:
page 62083/2

BSH servo motors:
page 62110/2

BMH servo motors:
page 62100/2

Servo drive/motor
combinations: page 62080/5

Lexium 32 motion control

BSH servo motors

Option: GBY angular planetary gearboxes

References

PF08037



Size	Gear ratio	Reference	Weight kg
GBY 60	3:1, 4:1, 5:1 and 8:1	GBY 060●●● K	1.700
	12:1, 20:1 and 40:1	GBY 060●●● K	1.900
GBY 80	3:1, 4:1, 5:1 and 8:1	GBY 080●●● K	4.400
	12:1, 20:1 and 40:1	GBY 080●●● K	5.000
GBY 120	3:1, 4:1, 5:1 and 8:1	GBY 120●●● K	12.000
	12:1, 20:1 and 40:1	GBY 120●●● K	14.000

GBY ●●●●● K angular planetary gearbox

To order a GBY angular planetary gearbox, complete each reference as follows:

Size	Casing diameter	GBY	●●●	●●●	K
Size	60 mm		060		
	80 mm		080		
	120 mm		120		
Gear ratio	3:1			003	
	4:1			004	
	5:1			005	
	8:1			008	
	12:1			012	
	20:1			020	
	40:1			040	
Mounting with GBK adaptation kit (see page 62116/7)					K

BSH servo motor/GBY angular planetary gearbox combinations

Gear ratios from 3:1 to 40:1

Type of servo motor	Gear ratio						
	3:1	4:1	5:1	8:1	12:1	20:1	40:1
BSH 0551	GBY 060	GBY 060	GBY 060	GBY 060	GBY 060	GBY 060	GBY 060
BSH 0552	GBY 060	GBY 060	GBY 060	GBY 060	GBY 060	GBY 060	–
BSH 0553	GBY 060	GBY 060	GBY 060	GBY 060	GBY 060	GBY 060	–
BSH 0701	GBY 060	GBY 060	GBY 060	GBY 060	GBY 060	GBY 080	GBY 080
BSH 0702	GBY 060	GBY 060	GBY 060	GBY 080	GBY 080	GBY 080	GBY 120
BSH 0703	GBY 080	GBY 080	GBY 080	GBY 080	GBY 080	GBY 080	GBY 120
BSH 1001	GBY 080	GBY 080	GBY 080	GBY 080	GBY 080	GBY 080	GBY 120
BSH 1002	GBY 080	GBY 080	GBY 080	GBY 120	GBY 080	GBY 120	–
BSH 1003	GBY 120	GBY 120	GBY 120	GBY 120	GBY 120	GBY 120	–
BSH 1004	GBY 120	GBY 120	GBY 120	–	GBY 120	–	–
BSH 1401	GBY 120	GBY 120	GBY 120	GBY 120	GBY 120	–	–

GBY 060

For these combinations, you must check that the application will not exceed the maximum gearbox output torque, see the values on our website www.schneider-electric.com.

References

To order a GBK adaptation kit, complete each reference as follows:

		GBK	●●●	●●●	●	F
Size of GBX or GBY planetary gearbox	Casing diameter	60 mm	060			
		80 mm	080			
		120 mm	120			
		160 mm	160			
Associated BSH servo motor	BSH 055			055		
	BSH 070			070		
	BSH 100			100		
	BSH 140			140		
Compatibility	Motor with any type of stack				0	
	Motor with 1 or 2 stacks				2	
	Motor with 1, 2 or 3 stacks				3	
	Motor with 4 stacks				4	
BSH servo motor adaptation						F

GBK adaptation kit/BSH servo motor combination

Type of gearbox	BSH servo motor													
	0551 ●	0552 ●	0553 ●	0701 ●	0702 ●	0703 ●	1001 ●	1002 ●	1003 ●	1004 ●	1401 ●	1402 ●	1403 ●	1404 ●
GBK 060 055 0 F	Compatible	Compatible	Compatible	Incompatible	Incompatible	Incompatible	Incompatible	Incompatible	Incompatible	Incompatible	Incompatible	Incompatible	Incompatible	Incompatible
GBK 060 070 2 F	Incompatible	Incompatible	Incompatible	Compatible	Compatible	Compatible	Incompatible	Incompatible	Incompatible	Incompatible	Incompatible	Incompatible	Incompatible	Incompatible
GBK 060 070 3F	Incompatible	Incompatible	Incompatible	Incompatible	Incompatible	Compatible	Incompatible	Incompatible	Incompatible	Incompatible	Incompatible	Incompatible	Incompatible	Incompatible
GBK 080 070 2F	Incompatible	Incompatible	Incompatible	Compatible	Compatible	Compatible	Incompatible	Incompatible	Incompatible	Incompatible	Incompatible	Incompatible	Incompatible	Incompatible
GBK 080 070 3F	Incompatible	Incompatible	Incompatible	Incompatible	Incompatible	Compatible	Incompatible	Incompatible	Incompatible	Incompatible	Incompatible	Incompatible	Incompatible	Incompatible
GBK 080 100 3F	Incompatible	Incompatible	Incompatible	Incompatible	Incompatible	Incompatible	Compatible	Compatible	Compatible	Compatible	Incompatible	Incompatible	Incompatible	Incompatible
GBK 120 070 2F	Incompatible	Incompatible	Incompatible	Compatible	Compatible	Compatible	Incompatible	Incompatible	Incompatible	Incompatible	Incompatible	Incompatible	Incompatible	Incompatible
GBK 120 070 3F	Incompatible	Incompatible	Incompatible	Incompatible	Incompatible	Compatible	Incompatible	Incompatible	Incompatible	Incompatible	Incompatible	Incompatible	Incompatible	Incompatible
GBK 120 100 3F	Incompatible	Incompatible	Incompatible	Incompatible	Incompatible	Incompatible	Compatible	Compatible	Compatible	Compatible	Incompatible	Incompatible	Incompatible	Incompatible
GBK 120 100 4F	Incompatible	Incompatible	Incompatible	Incompatible	Incompatible	Incompatible	Incompatible	Incompatible	Incompatible	Compatible	Incompatible	Incompatible	Incompatible	Incompatible
GBK 120 140 0F	Incompatible	Incompatible	Incompatible	Incompatible	Incompatible	Incompatible	Incompatible	Incompatible	Incompatible	Incompatible	Compatible	Compatible	Compatible	Compatible
GBK 160 100 3F	Incompatible	Incompatible	Incompatible	Incompatible	Incompatible	Incompatible	Compatible	Compatible	Compatible	Compatible	Incompatible	Incompatible	Incompatible	Incompatible
GBK 160 100 4F	Incompatible	Incompatible	Incompatible	Incompatible	Incompatible	Incompatible	Incompatible	Incompatible	Incompatible	Compatible	Incompatible	Incompatible	Incompatible	Incompatible
GBK 160 140 0F	Incompatible	Incompatible	Incompatible	Incompatible	Incompatible	Incompatible	Incompatible	Incompatible	Incompatible	Incompatible	Compatible	Compatible	Compatible	Compatible

Compatible
 Incompatible

(1) Weight of adaptation kit:
 ■ GBK 060●●●F: 0.200 kg
 ■ GBK 080●●●F: 0.450 kg
 ■ GBK 120●●●F: 0.650 kg
 ■ GBK 160●●●F: 0.900 kg